

# Operation Guide

TASKalfa 2320 TASKalfa 2020

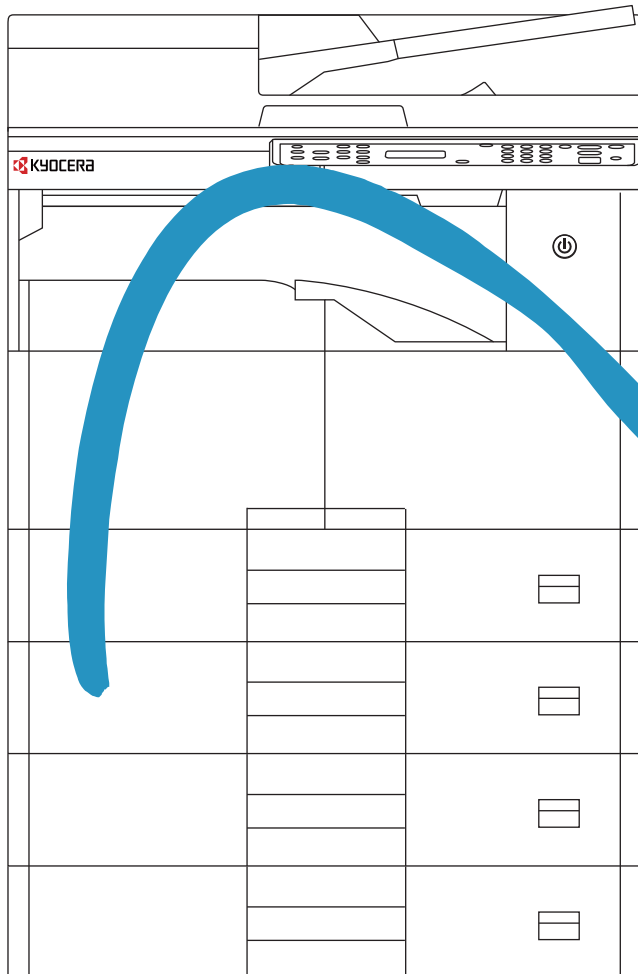

# Preface

This Operation Guide is intended to help you operate the machine correctly, perform routine maintenance, and take simple troubleshooting measures as needed so that the machine can always be used in the optimum condition.

Please read this Operation Guide before using the machine.

## **We recommend the use of our own brand supplies.**

Please use our genuine toner containers, which have passed rigorous quality control testing.

The use of non-genuine toner containers may cause failure.

We will not be liable for any damages caused by the use of third party supplies in this machine.

A label is affixed to our genuine supplies as shown below.

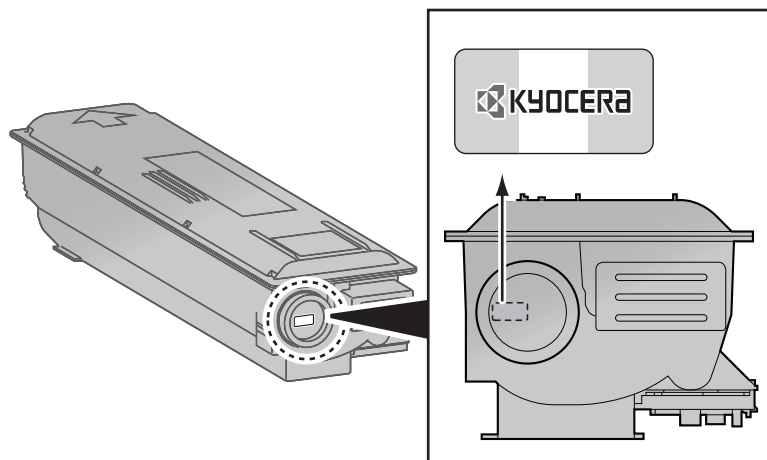

---

# Contents

Preface .....	i
Overview .....	vi
Machine Features .....	vii
Guides Provided with the Machine .....	x
About the Operation Guide (this Guide) .....	xi
Structure of the guide .....	xi
Conventions Used in This Guide .....	xii
Menu Map .....	xv

## **1 Legal and Safety Information ..... 1-1**

Notice .....	1-2
Safety Conventions in This Guide .....	1-2
Environment .....	1-3
Precautions for Use .....	1-3
Laser Safety (Europe) .....	1-4
Safety Instructions Regarding the Disconnection of Power .....	1-5
Legal Restriction on Copying/Scanning .....	1-5
EN ISO 7779 .....	1-5
EK1-ITB 2000 .....	1-5
Legal Information .....	1-6
Energy Saving Control Function .....	1-7
Automatic 2-Sided Copy Function .....	1-7
Resource Saving - Paper .....	1-7
Environmental benefits of "Power Management" .....	1-7

## **2 Installing and Setting up the Machine ..... 2-1**

Part Names .....	2-2
Machine Exterior .....	2-2
Connectors/Interior .....	2-4
With Optional Equipments Attached .....	2-5
Determining the Connection Method and Preparing Cables .....	2-6
Connection Example .....	2-6
Preparing Necessary Cables .....	2-6
Connecting Cables .....	2-7
Connecting USB Cable .....	2-7
Connecting the Power Cable .....	2-7
Power On/Off .....	2-8
Power On .....	2-8
Power Off .....	2-9
Installing Software .....	2-10
Software on Product Library Disc (Windows) .....	2-10
Installing Software in Windows .....	2-11
Uninstalling the Software .....	2-16
Setting the Shared Printer .....	2-17
Installing Software in Mac Computer .....	2-18
KYOCERA Client Tool .....	2-19
Setting WIA Driver .....	2-20
Administrator User Name and Password .....	2-21
Administrator Setting .....	2-21
Setting Energy Saver Function .....	2-23
Sleep and Sleep Timer .....	2-23
Power Off Timer .....	2-24
Checking the Counter .....	2-27

<b>3</b>	<b>Preparation before Use .....</b>	<b>3-1</b>
	<b>Using the Operation Panel .....</b>	<b>3-2</b>
	Operation Panel Keys .....	3-2
	Operation Method .....	3-3
	Display for Originals and Paper .....	3-4
	<b>Loading Paper .....</b>	<b>3-5</b>
	Before Loading Paper .....	3-6
	Loading in the Cassettes .....	3-7
	Loading Paper in the Multi Purpose Tray .....	3-10
	Specifying Paper Size and Media Type .....	3-13
<b>4</b>	<b>Printing from PC .....</b>	<b>4-1</b>
	<b>Printing from PC .....</b>	<b>4-2</b>
	Printer Driver Print Settings .....	4-5
	Printer Driver Help .....	4-6
	Changing the Default Printer Driver Settings (Windows 10) .....	4-6
	Canceling Jobs .....	4-6
	<b>Using Print Box .....</b>	<b>4-8</b>
	Saving Document to a Print Box .....	4-9
	Printing Document from Print Box .....	4-10
<b>5</b>	<b>Operation on the Machine .....</b>	<b>5-1</b>
	<b>Loading Originals .....</b>	<b>5-2</b>
	Placing Originals on the Platen .....	5-2
	Loading Originals in the Document Processor (Option) .....	5-3
	<b>Checking the Equipment's Serial Number .....</b>	<b>5-5</b>
	<b>Copying .....</b>	<b>5-6</b>
	Basic Operation .....	5-6
	Interrupt Copy .....	5-7
	ID Card Copy .....	5-8
	Using Various Functions .....	5-11
	Program .....	5-26
	Canceling Jobs .....	5-30
	<b>Scanning .....</b>	<b>5-31</b>
	Scan the Image to the Specified Destination .....	5-33
	Scan the Image by Selecting the Destination (Quick Scan) .....	5-35
	Scanning using TWAIN .....	5-36
	Canceling Jobs .....	5-37
<b>6</b>	<b>Checking the Status .....</b>	<b>6-1</b>
	<b>Checking Job Status .....</b>	<b>6-2</b>
	<b>Checking Job History .....</b>	<b>6-4</b>
	<b>Pause and Resumption of Jobs .....</b>	<b>6-7</b>
	<b>Canceling the Jobs in Printing/Waiting .....</b>	<b>6-8</b>
	<b>Checking Device Status .....</b>	<b>6-9</b>
	<b>Checking the Remaining Amount of Toner and Paper .....</b>	<b>6-10</b>
	<b>Checking from KYOCERA Client Tool .....</b>	<b>6-11</b>
<b>7</b>	<b>System Menu and KYOCERA Client Tool .....</b>	<b>7-1</b>
	<b>Default Settings on the Machine (System Menu) .....</b>	<b>7-2</b>
	System Menu Settings .....	7-3
	Report .....	7-4
	System .....	7-5
	Admin/Accounting .....	7-5
	Common Settings .....	7-5
	Copy .....	7-14

	Printer .....	7-15
	Adjust/Maint. (Adjustment/Maintenance) .....	7-15
	<b>Default Settings on the PC (KYOCERA Client Tool) .....</b>	<b>7-16</b>
	Operation Method .....	7-16
	Screen Overview .....	7-17
	Configuring the Administrative Settings .....	7-19
	Scan Destination Settings .....	7-20
	Quick Scan/TWAIN Settings .....	7-23
	Print Box Settings .....	7-26
<b>8</b>	<b>Job Accounting .....</b>	<b>8-1</b>
	<b>Overview of Job Accounting .....</b>	<b>8-2</b>
	<b>Enabling Job Accounting .....</b>	<b>8-3</b>
	<b>Setting an Account .....</b>	<b>8-4</b>
	Adding an Account .....	8-4
	Restricting the Use of the Machine .....	8-6
	Editing an Account .....	8-7
	Deleting an Account .....	8-8
	Job Accounting when Sharing the Printer .....	8-9
	Unknown ID Job .....	8-11
	<b>Configuring Job Accounting .....</b>	<b>8-12</b>
	Default Setting .....	8-12
	Counting the Number of Pages Printed .....	8-13
	Account. Report (Accounting Report) .....	8-14
	<b>Using Job Accounting .....</b>	<b>8-15</b>
	Login/Logout .....	8-15
	Printing When Sharing the Printer .....	8-15
<b>9</b>	<b>Troubleshooting .....</b>	<b>9-1</b>
	<b>Regular Maintenance .....</b>	<b>9-2</b>
	Cleaning .....	9-2
	Toner Container Replacement .....	9-3
	Waste Toner Box Replacement .....	9-6
	<b>Troubleshooting .....</b>	<b>9-8</b>
	Solving Malfunctions .....	9-8
	Responding to Messages .....	9-11
	Clearing Paper Jams .....	9-16
<b>10</b>	<b>Appendix .....</b>	<b>10-1</b>
	<b>Optional Equipment .....</b>	<b>10-2</b>
	Overview of Optional Equipment .....	10-2
	<b>Character Entry Method .....</b>	<b>10-4</b>
	Using the Keys .....	10-4
	Characters That Can be Entered Using the Numeric Keys .....	10-4
	Entering Symbols .....	10-5
	Entering Characters .....	10-6
	<b>Paper .....</b>	<b>10-7</b>
	Basic Paper Specifications .....	10-7
	Choosing the Appropriate Paper .....	10-8
	Special Paper .....	10-11
	<b>Specifications .....</b>	<b>10-15</b>
	Common Functions .....	10-15
	Copy Functions .....	10-16
	Printer Functions .....	10-16
	Scanner Functions .....	10-17
	Document Processor (Reverse Automatic) (Option) .....	10-17
	Paper Feeder (300-sheet) (Option) .....	10-18

---

Duplex Unit (Option) .....	10-18
<b>Glossary</b> .....	<b>10-19</b>
<b>Index</b> .....	<b>Index-1</b>

# Overview

This machine has copy and print functions equipped as standard and can save scanned images on your computer.

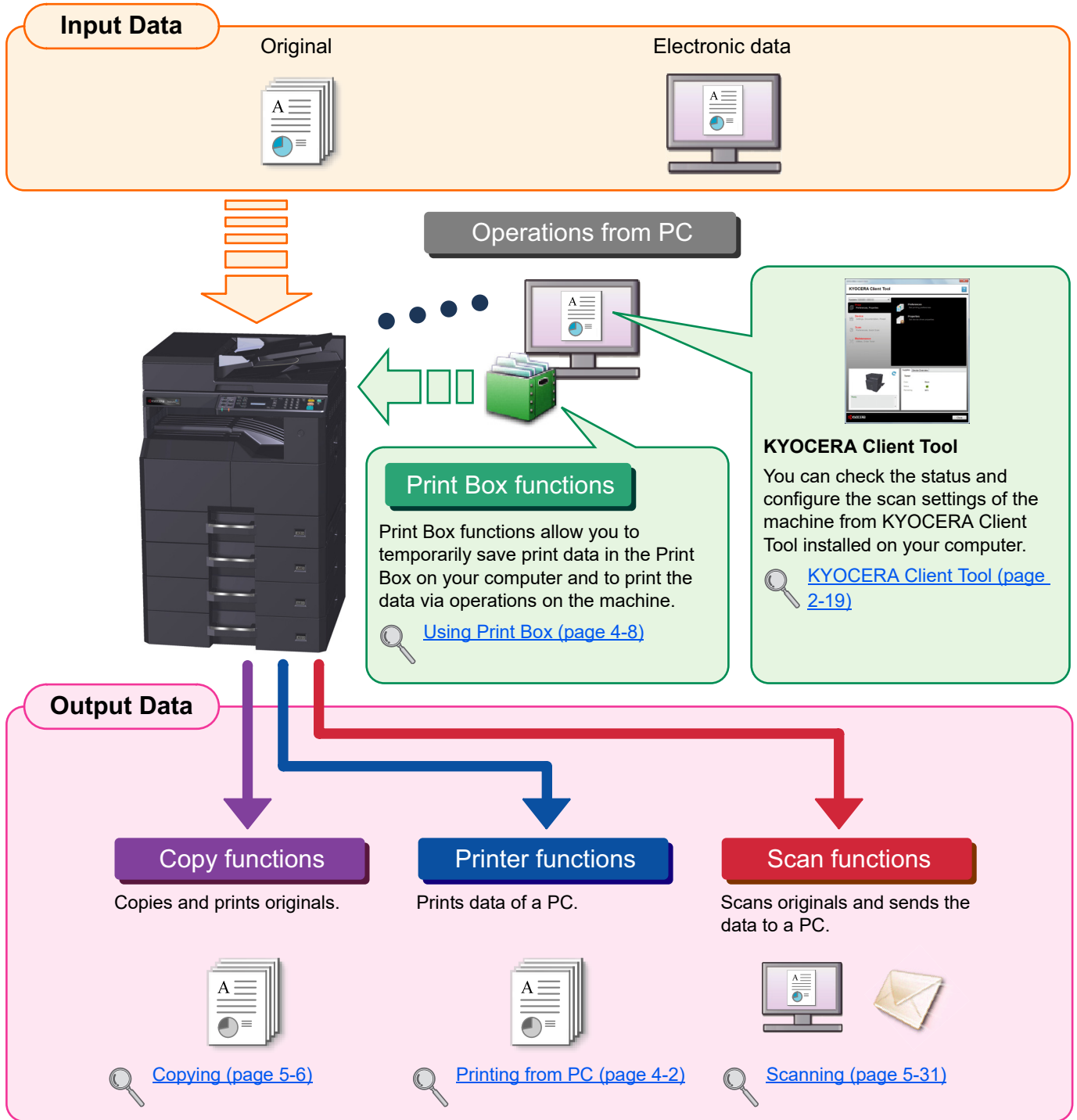









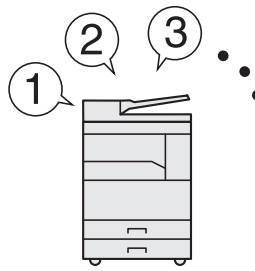

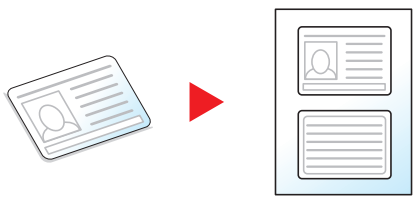

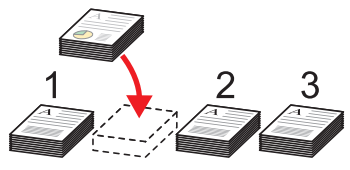
## NOTE

- Before using the machine, be sure to read [Legal and Safety Information on page 1-1](#).
- For preparations for use of the machine such as cable connections and software installation, refer to [Installing and Setting up the Machine on page 2-1](#).
- For information on how to use the operation panel, and load paper, refer to [Preparation before Use on page 3-1](#).

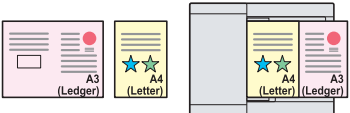

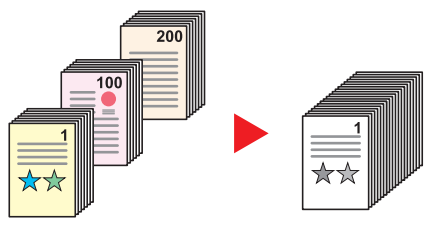

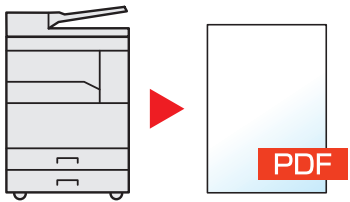

# Machine Features



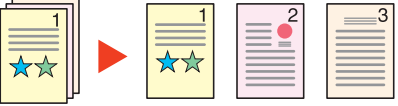

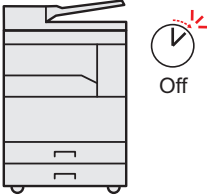

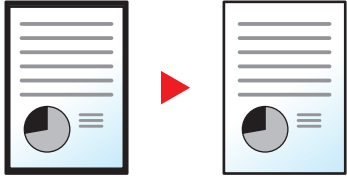
The machine is equipped with many useful functions. Here are some examples. For details, refer to [Operation on the Machine on page 5-1](#).



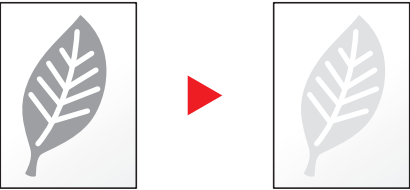

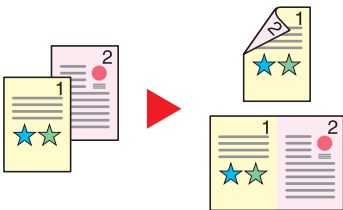

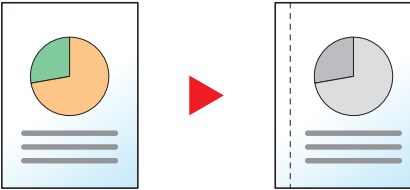
Optimize your office workflow		
<p><b>Access to frequently used functions with just one touch (Program)</b></p>  <p>You can preset frequently used functions. Once you set the functions as a preset program, all you need to do is press the program number to call up the functions. Using this program brings the same results even if operated by another person.</p> <p> <a href="#">Program (page 5-26)</a></p>	<p><b>Copy both sides of an ID card on a single sheet (ID Card Copy)</b></p>  <p>You can copy the front and back sides of an ID card on a single sheet of paper.</p> <p> <a href="#">ID Card Copy (page 5-8)</a></p>	<p><b>Interrupt other running jobs and execute your copy job immediately (Interrupt Copy)</b></p>  <p>You can interrupt other running jobs and execute your copy job immediately.</p> <p>When other users are copying a large number of sheets, this function allows you to interrupt those jobs and make your copies immediately.</p> <p>When the interruption copy ends, the machine resumes the paused print jobs.</p> <p> <a href="#">Interrupt Copy (page 5-7)</a></p>



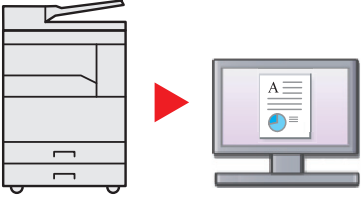

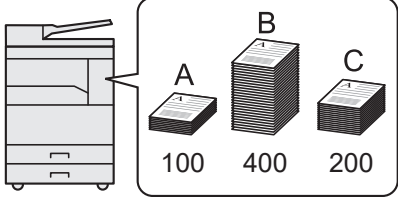
Optimize your office workflow		
<p><b>Scan originals of different sizes at a time (Mixed Size Originals)</b></p>  <p>It is useful when preparing conference materials.</p> <p>You can set the different sized originals at one time so you don't need to reset the originals regardless of size.</p> <p> <a href="#">Mixed Size Orig. (Mixed Size Originals) (page 5-22)</a></p>	<p><b>Scan a large number of originals in separate batches and produce as one job (Continuous Scan)</b></p>  <p>It is useful when preparing many-page handouts.</p> <p>When a large number of originals cannot be placed in the document processor at one time, the originals can be scanned in separate batches and then copied as one job.</p> <p> <a href="#">Continuous Scan (page 5-25)</a></p>	<p><b>Scan documents into high-compression PDF files (High-Compression PDF)</b></p>  <p>You can create documents in high-quality color PDF format with file capacities as small as black-and-white documents.</p> <p>This function allows you to scan documents into high-compression PDF files while maintaining the legibility.</p> <p>As full-color documents can be compressed to files as small as black-and-white documents, they are suitable for mail attachments.</p> <p> <a href="#">Quick Scan/TWAIN Settings (page 7-23)</a></p>

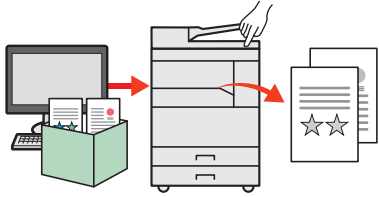

Optimize your office workflow	Save energy and cost	
<p><b>Separate each page of a scanned document into a single file (File separation)</b></p>  <p>You can create a single file for each page of a document.</p> <p>A single file is created and saved for each page of the original that was scanned.</p> <p>A three-digit serial number such as abc_001.pdf or abc_002.pdf is attached to the end of the file name.</p> <p> <a href="#">Quick Scan/TWAIN Settings (page 7-23)</a></p>	<p><b>Save energy as needed (Sleep / Power Off)</b></p>  <p>The machine is equipped with the Energy Saver function that automatically turns off the power or puts the machine into Sleep Mode.</p> <p> <a href="#">Setting Energy Saver Function (page 2-23)</a></p>	<p><b>Erase black shadows that appear at the edges of a copy (Border Erase)</b></p>  <p>This function allows you to print documents without copying unnecessary portions so that you can save toner consumption.</p> <p>You can remove the shadows that appear around the border of a copy when the original is scanned. You can also remove the shadows that appear at the border and at the center of the copy when a book is scanned. This creates a more attractive document.</p> <p> <a href="#">Border Erase (page 5-24)</a></p>

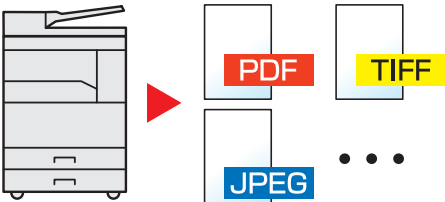
Save energy and cost		Create attractive documents
<p><b>Use less toner for printing (EcoPrint)</b></p>  <p>You can save toner consumption with this function.</p> <p>When you only need to check the printed content, such as a trial print run or documents for internal confirmation, use this function to save toner.</p> <p>Use this function when a high-quality print is not required.</p> <p> <a href="#">EcoPrint (page 5-22)</a></p>	<p><b>Print multiple originals onto one sheet (Duplex / Combine)</b></p>  <p>You can print originals on both sides of the paper. You can also print multiple originals onto one sheet.</p> <p> <a href="#">Combine (page 5-18)</a> <a href="#">Duplex (page 5-15)</a></p>	<p><b>Add margins for stapling (Margin)</b></p>  <p>This is convenient when preparing materials to be filed.</p> <p>The copy image can be shifted to add a margin for binding the copies.</p> <p>When the copies are two-sided, the margins on the front and back sides can be aligned to the same position.</p> <p> <a href="#">Margin (page 5-23)</a></p>

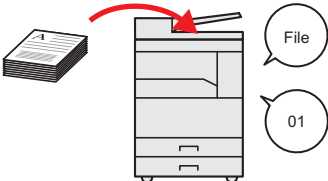
Create attractive documents	Strengthen security	
<p><b>Scan originals in color and send them to a PC (Scan)</b></p>  <p>You can scan originals and convert them into electronic data, such as a color PDF.</p> <p> <a href="#">Scanning (page 5-31)</a></p>	<p><b>Manage the copy/print count by account (Job Accounting)</b></p>  <p>You can check and restrict the copy/print count by account by assigning an account ID to each account.</p> <p> <a href="#">Overview of Job Accounting (page 8-2)</a></p>	<p><b>Prevent loss of finished documents (Print Box)</b></p>  <p>You can temporarily save a printer document in a Print Box of your computer. Printing the document from the machine can prevent someone from taking your document. With a PIN code assigned to the Print Box, you can further strengthen security.</p> <p> <a href="#">Using Print Box (page 4-8)</a></p>

Use functions more efficiently	
<p><b>Specify an image file format (File format)</b></p>  <p>You can select from various file formats when storing images.</p> <p> <a href="#">Quick Scan Settings (page 7-24)</a></p>	<p><b>Add a file name (File Name Entry)</b></p>  <p>This function makes it easier to check the job history and status. You can add a name and job number to a job.</p> <p> <a href="#">File Name Entry (page 5-25)</a></p>

# Guides Provided with the Machine

The following guides are provided with the machine. Refer to each guide as needed. The contents of the guides are subject to change without notice for the purpose of improvement of machine performance.

## Printed guides

**Start using the machine quickly**



### Quick Guide

Explains how to use basic functions of the machine.

**For safe use of the machine**



### Safety Guide

Provides safety and cautionary information for installation and use of the machine. Be sure to read this guide before using the machine.



### Safety Guide (TASKalfa 2320/TASKalfa 2020)

Indicates the space required for machine installation, and describes the cautionary labels and other safety information. Be sure to read this guide before using the machine.

## Guides (PDF) on the Product Library disc

**Use the machine thoughtfully**



### Operation Guide (This Guide)

Explains how to load paper and perform copy, print and scan operations, and indicates default settings and other information.

**Print data from a computer**



### Printer Driver User Guide

Explains how to install the printer driver and use the printer function.

**Use KYOCERA Client Tool**



### KYOCERA Client Tool User Guide

Explains how to use KYOCERA Client Tool.

Install the Adobe Reader (version 8.0 or later) to view the manuals on the Product Library disc.

# About the Operation Guide (this Guide)

## Structure of the guide

The Operation Guide contains the following chapters.

Chapter		Contents
1	<b>Legal and Safety Information</b>	Provides precautions regarding use of the machine and trademark information.
2	<b>Installing and Setting up the Machine</b>	Explains part names, cable connections, installation of the software, and other matters related to administration of the machine.
3	<b>Preparation before Use</b>	Explains preparations and settings that are required in order to use the machine, such as how to use the operation panel, and load paper.
4	<b>Printing from PC</b>	Explains functions that are available when the machine is used as a printer.
5	<b>Operation on the Machine</b>	Explains the basic procedures for using the machine, such as placing originals, making copies, and scanning.
6	<b>Checking the Status</b>	Explains how to check the status of a job and the job history, and how to cancel jobs being printed or waiting to print. Also explains how to check paper and toner levels, and how to check the device status.
7	<b>System Menu and KYOCERA Client Tool</b>	Explains System Menu related to overall machine operation and utilities.
8	<b>Job Accounting</b>	Explains job accounting.
9	<b>Troubleshooting</b>	Explains what to do when toner runs out, an error is displayed, or a paper jam or other problem occurs.
10	<b>Appendix</b>	Describes convenient options that are available for the machine. Provides information on media types and paper sizes, and gives a glossary of terms. Explains how to enter characters, and lists the specifications of the machine.

# Conventions Used in This Guide

Adobe Reader X is used as an example in the explanations below.

Click an item in the Table of Contents to jump to the corresponding page.

Click to move from the current page to the previously displayed page. This is convenient when you want to return to the page from which you jumped to the current page.

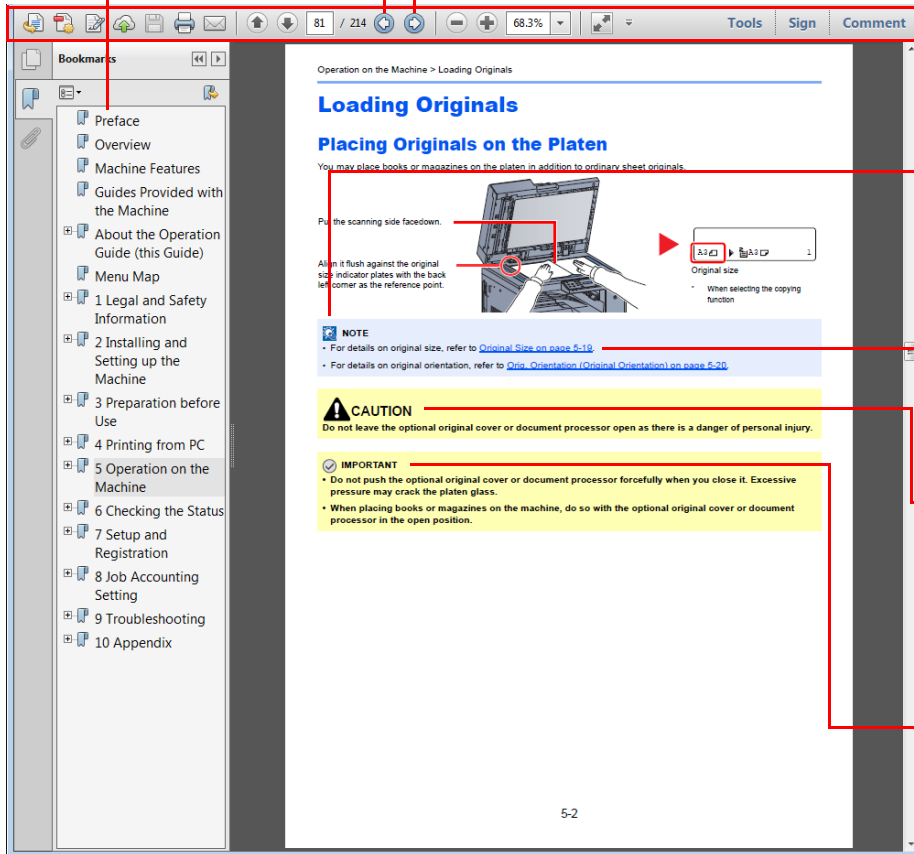

**NOTE**

Indicates supplemental explanations and reference information for operations.

**Refer to**

Click the underlined text to jump to the corresponding page.

**CAUTION**

Indicates that personal injury or mechanical damage may result from insufficient attention to or incorrect compliance with the related points.

**IMPORTANT**

Indicates operational requirements and restrictions to operate the machine correctly, and avoid damage to the machine or property.

**NOTE**

The items that appear in Adobe Reader vary depending on how it is used. If the Table of Contents or tools do not appear, refer to Adobe Reader Help.

Certain items are indicated in this guide by the conventions described below.

Convention	Description	Example
[ <b>Bold</b> ]	Indicates keys on the operation panel and buttons on your computer screen.	Press the [ <b>Start</b> ] key. Click the [ <b>OK</b> ] button.
[Regular]	Indicates a message or setting displayed on the message display.	[Ready to copy.] appears in the message display. Press the [ <b>▲</b> ] or [ <b>▼</b> ] key to select [On].
"Regular"	Indicates a message or setting displayed on the computer screen.	You can select from the "Print size" menu.

## Conventions used in operation procedures

Operation panel keys that are pressed are outlined in red.





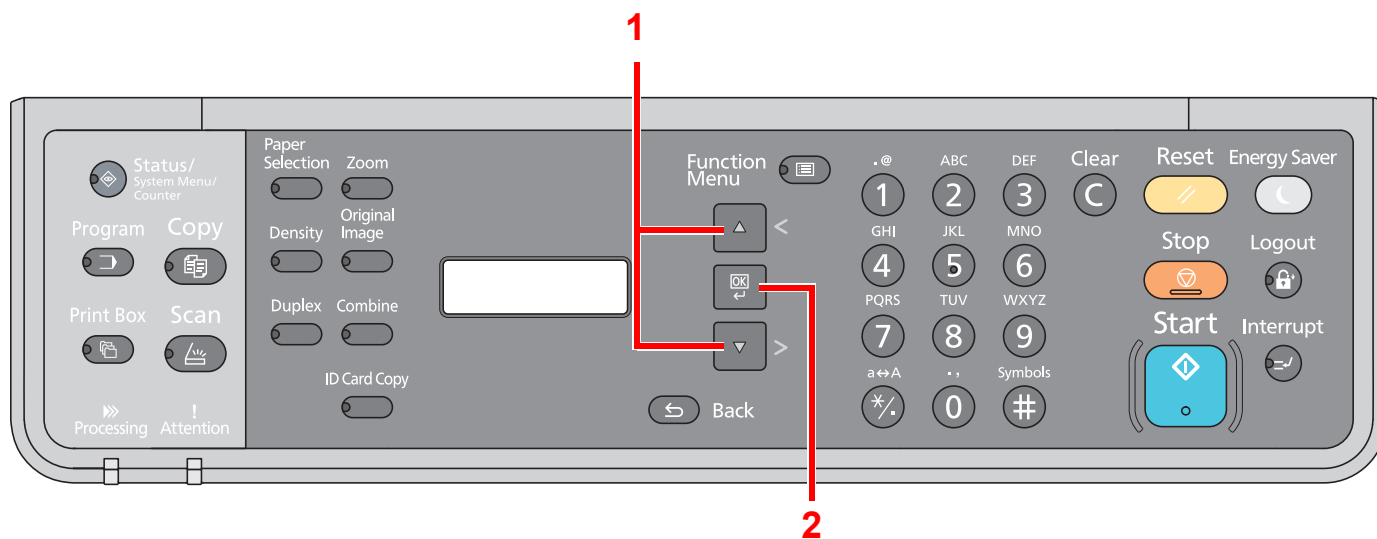



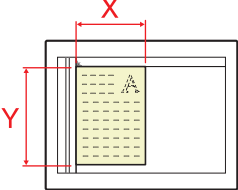

Procedures consisting of a sequence of operation panel actions or computer operations are numbered as shown below.

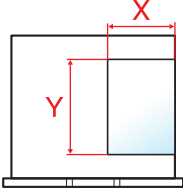

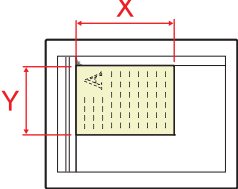
## Size and Orientation of Originals and Paper

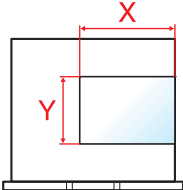
Original sizes and paper sizes such as A4, B5, and Letter can be used in both the horizontal and vertical orientations. To distinguish the orientations when these sizes are used, "-R" is added to sizes used in the horizontal orientation. The following icons are used to indicate original and paper placement orientations on the message display.

Orientation		Setting Position (X: Width, Y: Length)	Display	Indicated Size in this Guide <sup>*1</sup>
Vertical	Original	 Original	 Original	A4, B5, Letter, etc.
	Paper	 Paper	 Paper	
Horizontal	Original	 Original	 Original	A4-R, B5-R, Letter-R, etc.
	Paper	 Paper	 Paper	

\*1 Original/paper sizes that can be used vary depending on the function and source tray. For details, refer to [Specifications on page 10-15](#).

# Menu Map

(The names displayed on the message display are used here. These may differ from the referenced titles.)

## Copy



Paper Selection



Paper Selection ([page 5-13](#))

Zoom



Zoom ([page 5-14](#))

Density



Density ([page 5-15](#))

Original Image



Original Image ([page 5-15](#))

Duplex



Duplex ([page 5-15](#))

Combine



Combine ([page 5-18](#))

ID Card Copy



ID card Copy ([page 5-8](#))

## Copy



Function Menu



Collate/Offset ([page 5-20](#))

Original Size ([page 5-20](#))

Orig. Orientation ([page 5-21](#))

Mixed Size Orig. ([page 5-22](#))

EcoPrint ([page 5-22](#))

Backgrnd Density ([page 5-22](#))

Margin ([page 5-23](#))

Border Erase ([page 5-24](#))

Continuous Scan ([page 5-25](#))

Auto Rotation ([page 5-25](#))

File Name Entry ([page 5-25](#))

## Scan



Ready to scan. ([page 5-33](#))

## Program



Select program ([page 5-26](#))



Print Box



Print Box ([page 4-10](#))

Status/  
System Menu/  
Counter



Status	Print Job Status ( <a href="#">page 6-2</a> )	
	Print Job Log ( <a href="#">page 6-4</a> )	
	Send Job Log ( <a href="#">page 6-4</a> )	
	Scanner ( <a href="#">page 6-9</a> )	
	Printer ( <a href="#">page 6-9</a> )	
	Toner Status ( <a href="#">page 6-10</a> )	
	Paper Status ( <a href="#">page 6-10</a> )	
Report	Report Print	Menu Map ( <a href="#">page 7-4</a> )
		Status Page ( <a href="#">page 7-4</a> )
		Service Status ( <a href="#">page 7-4</a> )
Counter ( <a href="#">page 2-27</a> )		
System	I/F Block Set. ( <a href="#">page 7-5</a> )	
Admin/Accounting	Admin. Setting ( <a href="#">page 2-21</a> )	
	Job Account. Set.	Job Accounting ( <a href="#">page 8-3</a> )
		Account. Report ( <a href="#">page 8-14</a> )
		Total Accounting ( <a href="#">page 8-13</a> )
		Each Job Account ( <a href="#">page 8-13</a> )
		Account. List ( <a href="#">page 8-4</a> )
		Default Setting ( <a href="#">page 8-12</a> )
	Unknown ID Job ( <a href="#">page 8-11</a> )	

Common Settings	Language ( <a href="#">page 7-5</a> )		
	Default Screen ( <a href="#">page 7-6</a> )		
	Sound	Buzzer ( <a href="#">page 7-6</a> )	
	Display Bright. ( <a href="#">page 7-6</a> )		
	Quiet Mode ( <a href="#">page 7-6</a> )		
	Orig./Paper Set.	Custom Orig.Size ( <a href="#">page 7-7</a> )	
		Custom PaperSize ( <a href="#">page 7-7</a> )	
		Cassette 1 Set.	Cassette 1 Size ( <a href="#">page 7-9</a> )
			Cassette 1 Type ( <a href="#">page 7-9</a> )
		Cassette 2 Set.	Cassette 2 Size ( <a href="#">page 7-9</a> )
			Cassette 2 Type ( <a href="#">page 7-9</a> )
		Cassette 3 Set.	Cassette 3 Size ( <a href="#">page 7-9</a> )
			Cassette 3 Type ( <a href="#">page 7-9</a> )
		Cassette 4 Set.	Cassette 4 Size ( <a href="#">page 7-9</a> )
			Cassette 4 Type ( <a href="#">page 7-9</a> )
		MP Tray Set.	MP Tray Size ( <a href="#">page 7-9</a> )
			MP Tray Type ( <a href="#">page 7-9</a> )
		Media Type Set. ( <a href="#">page 7-7</a> )	
		Auto Detect Orig. ( <a href="#">page 7-7</a> )	
		Media for Auto ( <a href="#">page 7-8</a> )	
		Def. PaperSource ( <a href="#">page 7-8</a> )	
	SpicalPaper Act. ( <a href="#">page 7-8</a> )		
	Preset Limit ( <a href="#">page 7-11</a> )		
	Measurement ( <a href="#">page 7-11</a> )		
	Error Handling	DuplexPaperError ( <a href="#">page 7-11</a> )	
		PaperMismatchErr ( <a href="#">page 7-11</a> )	
	Timer Setting	Err. Clear Timer ( <a href="#">page 7-12</a> )	
		Sleep Timer ( <a href="#">page 7-12</a> )	
		PanelReset Timer ( <a href="#">page 7-12</a> )	
		Interrupt Clear ( <a href="#">page 7-12</a> )	
		Power Off Rule ( <a href="#">page 7-12</a> )	
		Power Off Timer ( <a href="#">page 7-12</a> )	
		Auto Err. Clear ( <a href="#">page 7-12</a> )	
Auto Panel Reset ( <a href="#">page 7-12</a> )			

Common Settings	Function Default	Original Image ( <a href="#">page 7-13</a> )	
		Zoom ( <a href="#">page 7-13</a> )	
		Collate/Offset ( <a href="#">page 7-13</a> )	
		Orig. Orientation ( <a href="#">page 7-13</a> )	
		Border Erase ( <a href="#">page 7-13</a> )	
		Margin ( <a href="#">page 7-13</a> )	
		Backgrnd Density ( <a href="#">page 7-13</a> )	
		EcoPrint ( <a href="#">page 7-13</a> )	
		Auto Rotation ( <a href="#">page 7-13</a> )	
		File Name Entry ( <a href="#">page 7-13</a> )	
		Continuous Scan ( <a href="#">page 7-13</a> )	
	Detail Settings	2 in 1 Layout ( <a href="#">page 7-14</a> )	
		4 in 1 Layout ( <a href="#">page 7-14</a> )	
		Border Line ( <a href="#">page 7-14</a> )	
Orig. Binding ( <a href="#">page 7-14</a> )			
BookOrg. Binding ( <a href="#">page 7-14</a> )			
Finish. Binding ( <a href="#">page 7-14</a> )			
Copy	Paper Selection ( <a href="#">page 7-14</a> )		
	AutoPaperSelect. ( <a href="#">page 7-14</a> )		
	Auto % Priority ( <a href="#">page 7-14</a> )		
Printer	FormFeed TimeOut ( <a href="#">page 7-15</a> )		
Adjust/Maint.	Density Adj. ( <a href="#">page 7-15</a> )		
	Backgrnd Density ( <a href="#">page 7-15</a> )		
	Print Density ( <a href="#">page 7-15</a> )		
	Correct. Bk Line ( <a href="#">page 7-15</a> )		
	Service Settings	Drum Refresh ( <a href="#">page 7-15</a> )	

# 1 Legal and Safety Information

Please read this information before using your machine. This chapter provides information on the following topics.

Notice .....	1-2
Safety Conventions in This Guide .....	1-2
Environment .....	1-3
Precautions for Use .....	1-3
Laser Safety (Europe) .....	1-4
Safety Instructions Regarding the Disconnection of Power .....	1-5
Legal Restriction on Copying/Scanning .....	1-5
Legal Information .....	1-6
Energy Saving Control Function .....	1-7
Automatic 2-Sided Copy Function .....	1-7
Resource Saving - Paper .....	1-7
Environmental benefits of "Power Management" .....	1-7

# Notice

## Safety Conventions in This Guide

The sections of this guide and parts of the machine marked with symbols are safety warnings meant to protect the user, other individuals and surrounding objects, and ensure correct and safe usage of the machine. The symbols and their meanings are indicated below.

 **WARNING:** Indicates that serious injury or even death may result from insufficient attention to or incorrect compliance with the related points.

 **CAUTION:** Indicates that personal injury or mechanical damage may result from insufficient attention to or incorrect compliance with the related points.

## Symbols

The  symbol indicates that the related section includes safety warnings. Specific points of attention are indicated inside the symbol.

 ... [General warning]

 ... [Warning of high temperature]

The  symbol indicates that the related section includes information on prohibited actions. Specifics of the prohibited action are indicated inside the symbol.

 ... [Warning of prohibited action]

 ... [Disassembly prohibited]

The  symbol indicates that the related section includes information on actions which must be performed. Specifics of the required action are indicated inside the symbol.

 ... [Alert of required action]

 ... [Remove the power plug from the outlet]

 ... [Always connect the machine to an outlet with a ground connection]

Please contact your service representative to order a replacement if the safety warnings in this Operation Guide are illegible or if the guide itself is missing (fee required).

## Environment

The service environmental conditions are as follows:

<b>Temperature</b>	50 to 90.5 °F (10 to 32.5 °C) (But humidity should be 70% or less when temperature is 90.5 °F (32.5 °C).)
<b>Humidity</b>	10 to 80% (But temperature should be 86 °F (30 °C) or less when humidity is 80%.)

However, adverse environmental conditions may affect the image quality. Avoid the following locations when selecting a site for the machine.

- Avoid locations near a window or with exposure to direct sunlight.
- Avoid locations with vibrations.
- Avoid locations with drastic temperature fluctuations.
- Avoid locations with direct exposure to hot or cold air.
- Avoid poorly ventilated locations.

If the floor is delicate against casters, when this machine is moved after installation, the floor material may be damaged.

During copying, some ozone is released, but the amount does not cause any ill effect to one's health. If, however, the machine is used over a long period of time in a poorly ventilated room or when making an extremely large number of copies, the smell may become unpleasant. To maintain the appropriate environment for copy work, it is suggested that the room be properly ventilated.

## Precautions for Use

### Cautions when handling consumables



**CAUTION**

Do not attempt to incinerate parts which contain toner. Dangerous sparks may cause burns.

Keep parts which contain toner out of the reach of children.

If toner happens to spill from parts which contain toner, avoid inhalation and ingestion, as well as contact with your eyes and skin.

- If you do happen to inhale toner, move to a place with fresh air and gargle thoroughly with a large amount of water. If coughing develops, contact a physician.
- If you do happen to ingest toner, rinse your mouth with water and drink 1 or 2 cups of water to dilute the contents of your stomach. If necessary, contact a physician.
- If you do happen to get toner in your eyes, flush them thoroughly with water. If there is any remaining tenderness, contact a physician.
- If toner does happen to get on your skin, wash with soap and water.

Do not attempt to force open or destroy parts which contain toner.

## Other precautions

Return the exhausted toner container and waste toner box to your dealer or service representative. The collected toner container and waste toner box will be recycled or disposed in accordance with the relevant regulations.

Store the machine while avoiding exposure to direct sunlight.

Store the machine in a place where the temperature stays below 40 °C while avoiding sharp changes of temperature and humidity.

If the machine will not be used for an extended period of time, remove the paper from the cassette and the Multi Purpose (MP) Tray, return it to its original package and reseal it.

## Laser Safety (Europe)

Laser radiation could be hazardous to the human body. For this reason, laser radiation emitted inside this machine is hermetically sealed within the protective housing and external cover. In the normal operation of the product by user, no radiation can leak from the machine.

This machine is classified as Class 1 laser product under IEC/EN 60825-1:2014.

Regarding CLASS 1 laser products, information is provided on the rating label.

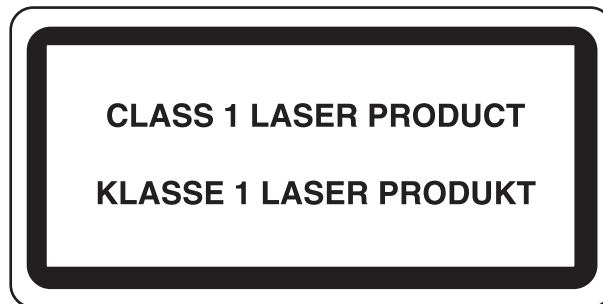

## Safety Instructions Regarding the Disconnection of Power

**Caution:** The power plug is the main isolation device! Other switches on the equipment are only functional switches and are not suitable for isolating the equipment from the power source.

**Attention:** Le débranchement de la fiche secteur est le seul moyen de mettre l'appareil hors tension. Les interrupteurs sur l'appareil ne sont que des interrupteurs de fonctionnement: ils ne mettent pas l'appareil hors tension.

## Legal Restriction on Copying/Scanning

It may be prohibited to copy/scan copyrighted material without permission of the copyright owner.

Copying/Scanning the following items is prohibited and may be penalized by law. It may not be limited to these items. Do not knowingly copy/scan the items that are not to be copied/scanned.

- Paper money
- Bank note
- Securities
- Stamp
- Passport
- Certificate

Local laws and regulations may prohibit or restrict copying/scanning of other items not mentioned above.



### NOTE

An original which resembles a bank note closely may not be copied properly in some rare cases.

## EN ISO 7779

Maschinenlärminformations-Verordnung 3. GPSGV, 06.01.2004: Der höchste Schalldruckpegel beträgt 70 dB (A) oder weniger gemäß EN ISO 7779.

## EK1-ITB 2000

Das Gerät ist nicht für die Benutzung im unmittelbaren Gesichtsfeld am Bildschirmarbeitsplatz vorgesehen. Um störende Reflexionen am Bildschirmarbeitsplatz zu vermeiden, darf dieses Produkt nicht im unmittelbaren Gesichtsfeld platziert werden.



## Legal Information

Copying or other reproduction of all or part of this guide without the prior written consent of KYOCERA Document Solutions Inc. is prohibited.

### Regarding Trade Names

- TASKalfa is a trademark or registered trademark of KYOCERA Document Solutions Inc.
- Microsoft, Windows, Windows Server and Internet Explorer are registered trademarks or trademarks of Microsoft Corporation in the U.S.A. and/or other countries.
- Adobe Acrobat, and Flash are registered trademarks of Adobe Systems Incorporated.
- IBM and IBM PC/AT are trademarks of International Business Machines Corporation.
- AppleTalk, Bonjour, Macintosh, and Mac OS are trademarks of Apple Inc., registered in the U.S. and other countries.

All other brands and product names are registered trademarks or trademarks of their respective companies. The designations <sup>TM</sup> and <sup>®</sup> will not be used in this Operation Guide.

## Energy Saving Control Function

To reduce energy consumption while in a waiting state, the device comes equipped with an energy saving control function for switching to **Sleep** as well as **Power Off Mode** where power consumption is automatically reduced to a minimum after a certain amount of time elapses since the device was last used.

### Sleep

The device automatically enters Sleep when 1 minute has passed since the copy function was last used. The amount of time of no activity that must pass before Sleep is activated may be lengthened. When printing in Sleep mode, the device returns to Sleep mode after it has finished printing. For more information see [Sleep and Sleep Timer on page 2-23](#).

### Power Off Mode

The device automatically turns its power off when 1 hour has passed since the device was last used. The amount of time of no activity that must pass before Power Off Mode is activated may be lengthened by changing the Power Off Timer setting. For more information see [Power Off Timer on page 2-24](#).

## Automatic 2-Sided Copy Function

This device includes 2-sided copying function. (This is optional for TASKalfa 2020.) For example, by copying two 1-sided originals onto a single sheet of paper as a 2-sided copy, it is possible to lower the amount of paper used. For more information refer to [Duplex on page 5-15](#).

Printing in duplex mode reduces paper consumption and contributes to the conservation of forest resources. Duplex mode also reduces the amount of paper that must be purchased, and thereby reduces cost. It is recommended that machines capable of duplex printing be set to use duplex mode by default.

## Resource Saving - Paper

For the preservation and sustainable use of forest resources, it is recommended that recycled as well as virgin paper certified under environmental stewardship initiatives or carrying recognised ecolabels, which meet EN 12281:2002\* or an equivalent quality standard, be used.

This machine also supports printing on 64 g/m<sup>2</sup> paper. Using such paper containing less raw materials can lead to further saving of forest resources.

\* : EN12281:2002 "Printing and business paper - Requirements for copy paper for dry toner imaging processes"

Your sales or service representative can provide information about recommended paper types.

## Environmental benefits of "Power Management"

To reduce power consumption when idle, this machine is equipped with a power management function that automatically activates energy-saving mode when the machine is idle for a certain period of time.

Although it takes the machine a slight amount of time to return to READY mode when in energy-saving mode, a significant reduction in energy consumption is possible. It is recommended that the machine be used with the activation time for energy-saving mode set to the default setting.

# 2 Installing and Setting up the Machine

This chapter provides information for the administrator of this machine, such as part names, cable connection, and software installation.

Part Names .....	2-2
Machine Exterior .....	2-2
Connectors/Interior .....	2-4
With Optional Equipments Attached .....	2-5
Determining the Connection Method and Preparing Cables .....	2-6
Connection Example .....	2-6
Preparing Necessary Cables .....	2-6
Connecting Cables .....	2-7
Connecting USB Cable .....	2-7
Connecting the Power Cable .....	2-7
Power On/Off .....	2-8
Power On .....	2-8
Power Off .....	2-9
Installing Software .....	2-10
Software on Product Library Disc (Windows) .....	2-10
Installing Software in Windows .....	2-11
Uninstalling the Software .....	2-16
Setting the Shared Printer .....	2-17
Installing Software in Mac Computer .....	2-18
KYOCERA Client Tool .....	2-19
Setting WIA Driver .....	2-20
Administrator User Name and Password .....	2-21
Administrator Setting .....	2-21
Setting Energy Saver Function .....	2-23
Sleep and Sleep Timer .....	2-23
Power Off Timer .....	2-24
Checking the Counter .....	2-27

# Part Names

## Machine Exterior

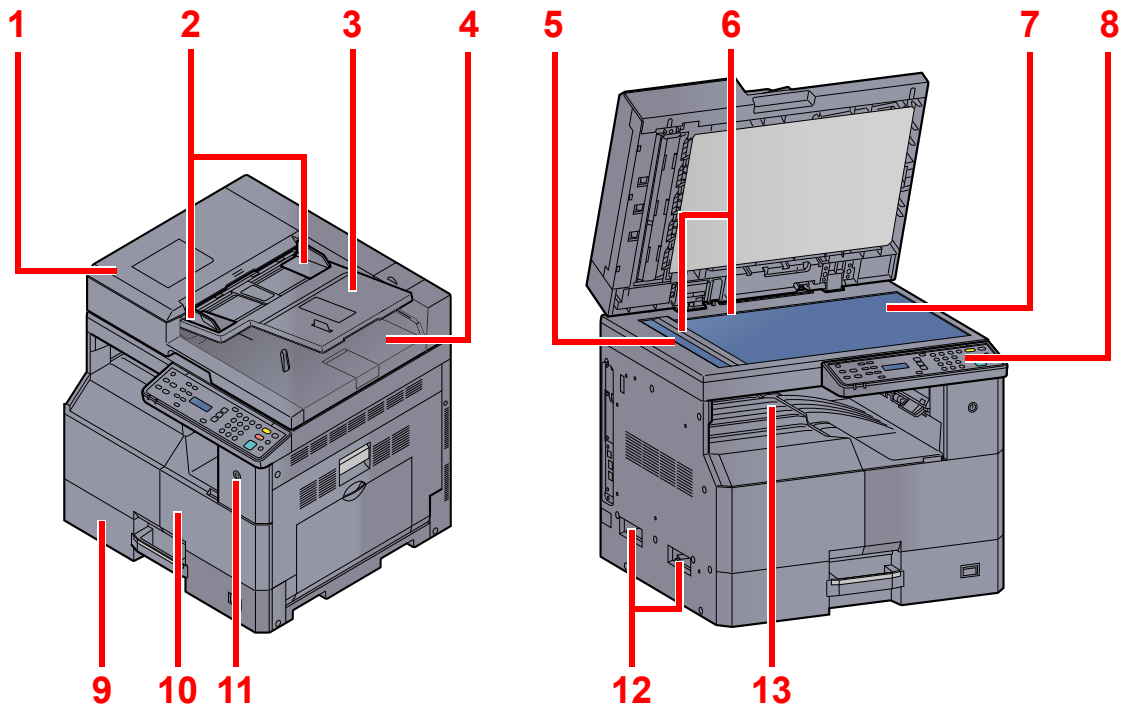

1 Document Processor (DP)

2 Original Width Guides

3 Original Table

4 Original Eject Table

5 Slit Glass

6 Original Size Indicator Plates

7 Platen

8 Operation Panel

9 Cassette 1

10 Front Cover

11 Power Switch

12 Handles

13 Inner Tray



[Optional Equipment \(page 10-2\)](#)

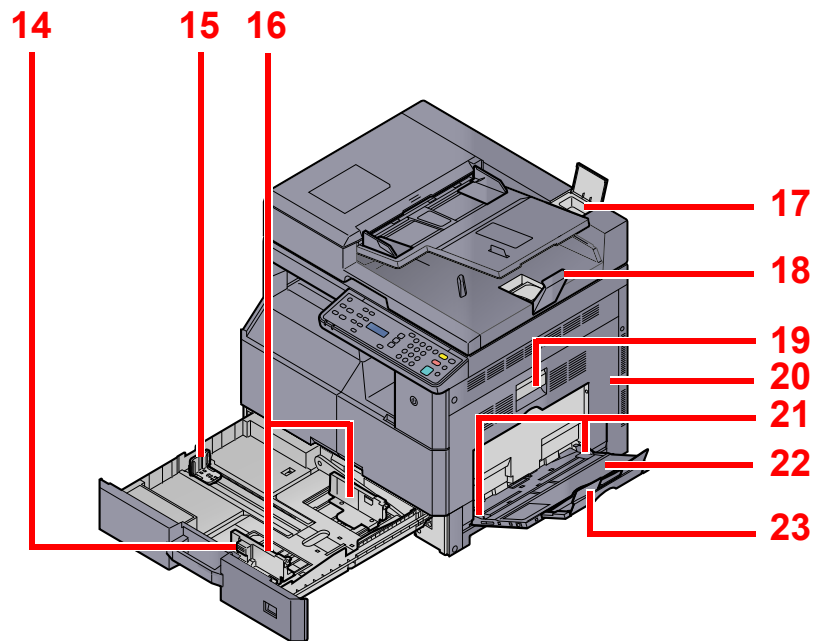

- 14 Paper Width Adjusting Tab
- 15 Paper Length Guide
- 16 Paper Width Guide
- 17 Cleaning Cloth Compartment
- 18 Original Stopper
- 19 Right Cover 1 Lever
- 20 Right Cover 1
- 21 Paper Width Guide
- 22 Multi Purpose Tray
- 23 Support Tray Section of the Multi Purpose Tray

## Connectors/Interior

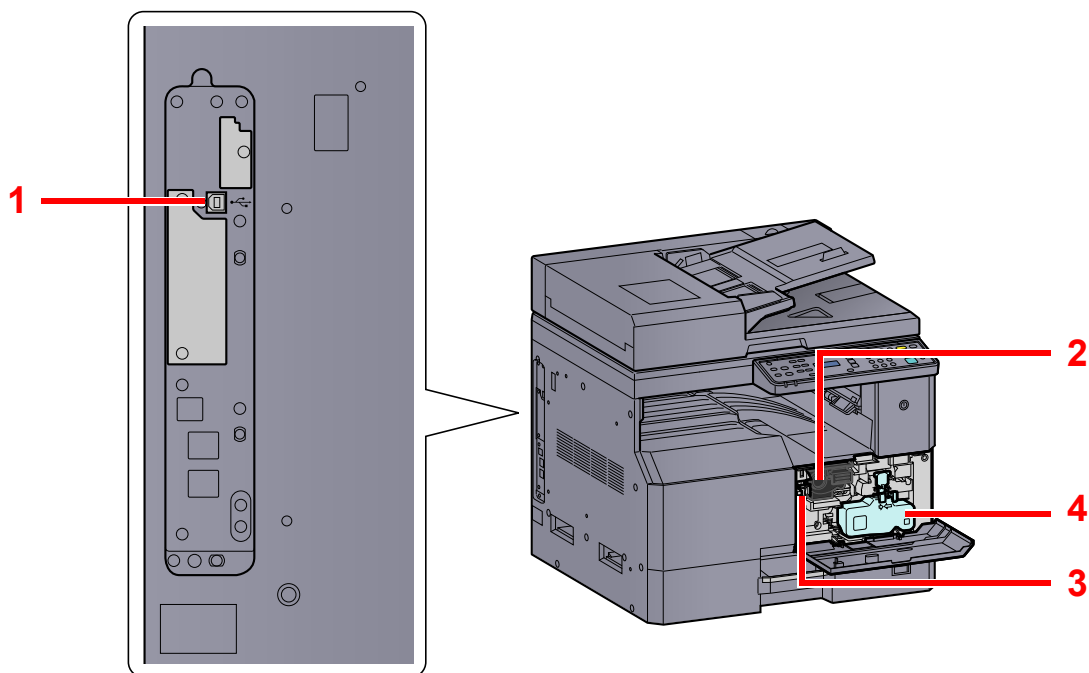

- 1 USB Interface Connector
- 2 Toner Container
- 3 Toner Container Lever
- 4 Waste Toner Box

## With Optional Equipments Attached

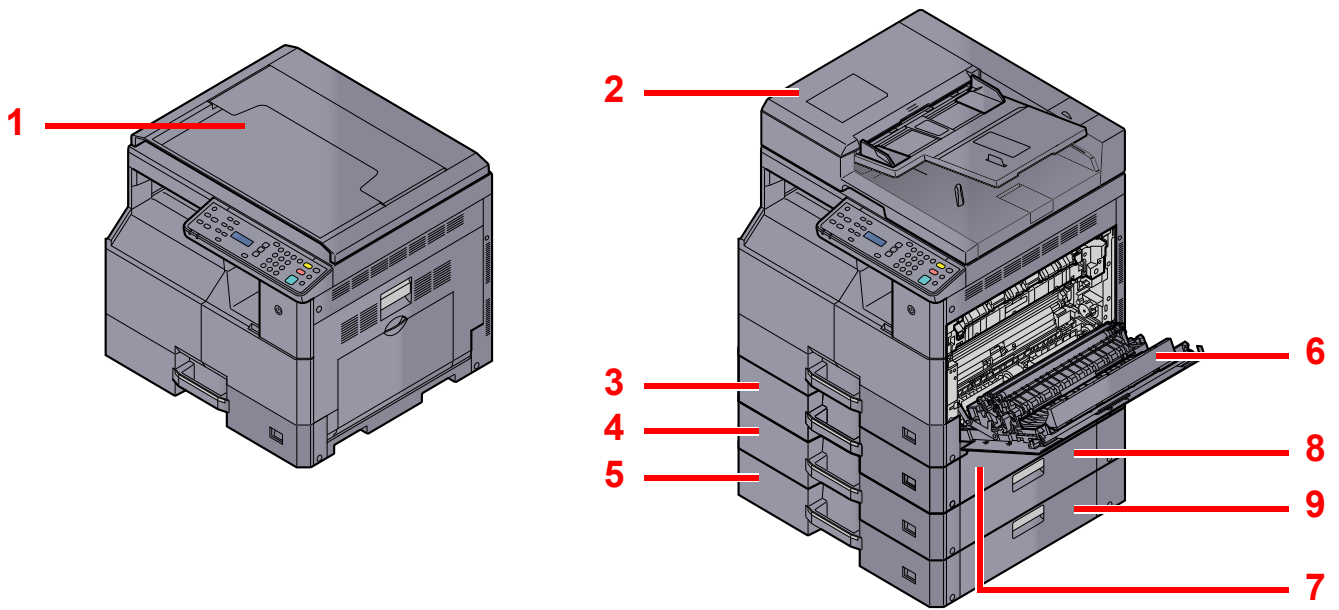

- 1 Original Cover
- 2 Document Processor (DP)
- 3 Cassette 2
- 4 Cassette 3
- 5 Cassette 4
- 6 Duplex Unit
- 7 Right Cover 2
- 8 Right Cover 3
- 9 Right Cover 4

 [Optional Equipment \(page 10-2\)](#)

# Determining the Connection Method and Preparing Cables

Check how to connect the machine to a PC, and prepare the necessary cables for your environment.

## Connection Example

Connect the machine to the PC by referring to the illustration below.

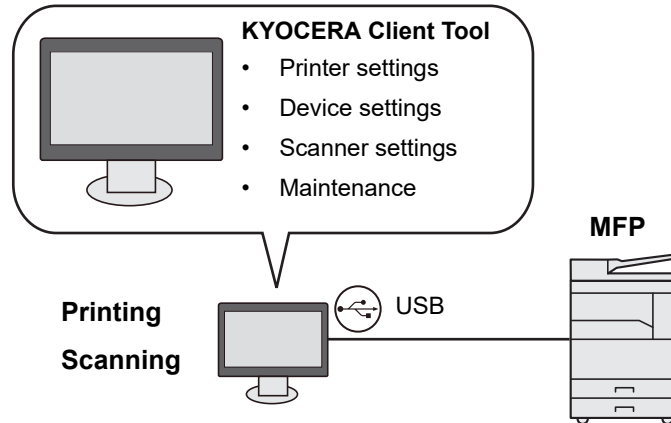

## Preparing Necessary Cables

Prepare the necessary cables according to the interface you use.

### Available Standard Interfaces

Connection Environment	Function	Necessary Cable
Connect a USB cable to the machine.	Printer/Scanner	USB2.0 compatible cable (Hi-Speed USB compliant, Max. 5.0 m, Shielded)



# Connecting Cables

## Connecting USB Cable

✔ **IMPORTANT**

If the power is on, turn the power switch off.

🔍 [Power Off \(page 2-9\)](#)

### 1 Connect the machine.

- 1 Connect the USB cable to the USB interface connector located on the left side of the body.

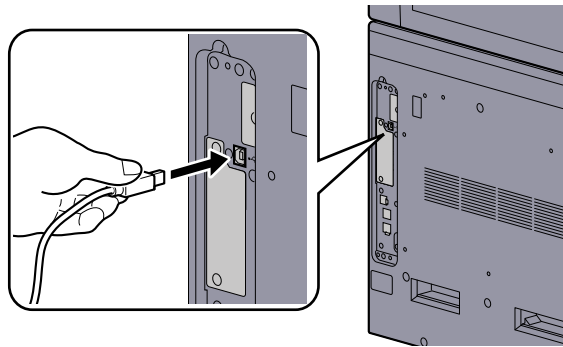

- 2 Connect the other end of the cable to the PC.

## Connecting the Power Cable

Connect one end of the supplied power cable to the machine and the other end to a power outlet.

✔ **IMPORTANT**

Only use the power cable that comes with the machine.

# Power On/Off

## Power On

When the [Energy Saver] indicator is lit... (Recovery from sleep)

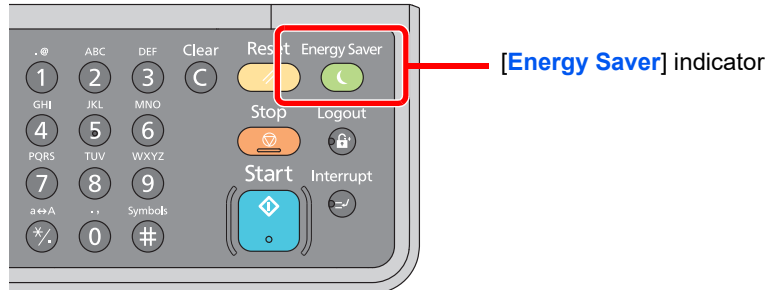

Press any key on the operation panel.

When the [Energy Saver] indicator is off...

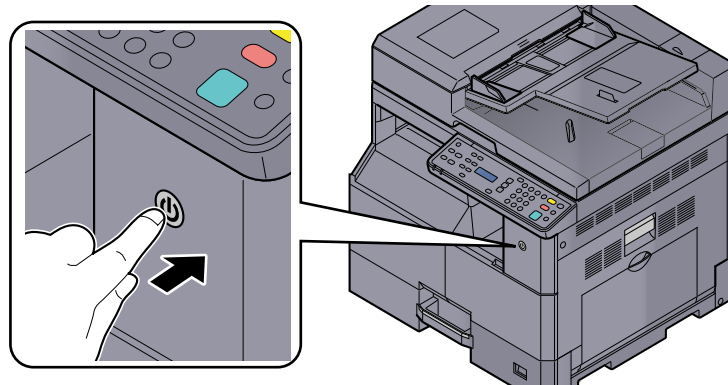

Turn the power switch on.

 **IMPORTANT**

When turning off the power switch, do not turn on the power switch again immediately. Wait more than 5 seconds, and then turn on the power switch.

## Power Off

### When not turning off the power switch... (sleep)

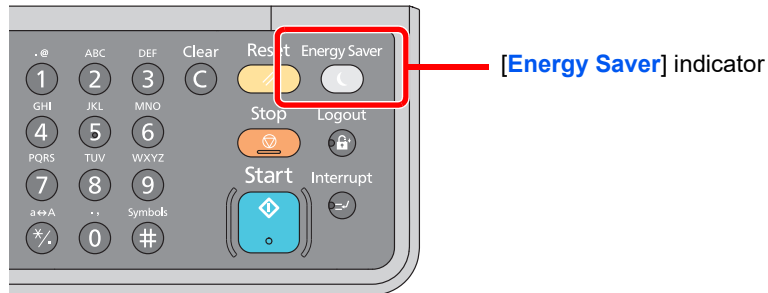

Press the [Energy Saver] key. The [Energy Saver] indicator will light up.

 [Sleep and Sleep Timer \(page 2-23\)](#)

### When turning off the power switch...

Note that when the power switch is turned off, the machine will be unable to automatically receive print data from computers.

#### IMPORTANT

When the [Processing] indicator is lit up or blinked, the machine is operating. Turning off the power switch while the machine is operating may cause it to malfunction.

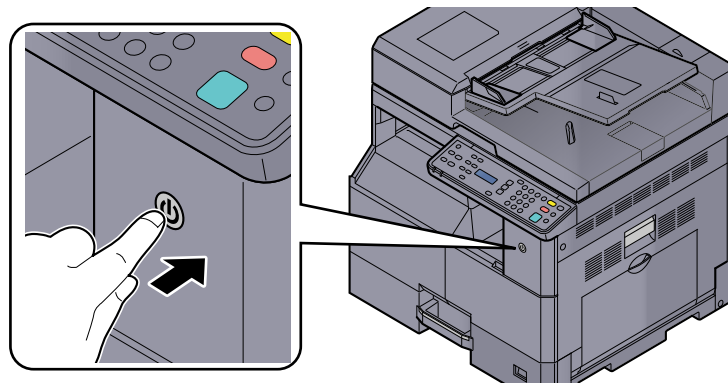

Turn the power switch off.

### In case of not using the machine for an extended period of time...

#### CAUTION

If this machine will be left unused for an extended period (e.g. overnight), turn it off at the power switch. If the machine will not be used for an even longer period of time (e.g. vacation), remove the power plug from the outlet as a safety precaution.

#### IMPORTANT

Remove paper from the cassettes and seal it in the paper storage bag to protect it from humidity.

# Installing Software

Install appropriate software on your PC from the included Product Library disc if you want to use the printer function of this machine or perform TWAIN / WIA transmission from your PC.

## Software on Product Library Disc (Windows)

You can use either [[Express Install](#)] or [[Custom Install](#)] can be selected for the installation method. [[Express Install](#)] is set as the standard installation method. For items that cannot be installed by using [[Express Install](#)], install them by using [[Custom Install](#)]. For how to use [[Custom Install](#)], refer to [Custom Install on page 2-13](#).

Software	Description	Express Install
<b>KYOCERA Client Tool</b>	Utility that enables current and all supported devices status, features and settings to be accessed. When KYOCERA Client Tool is installed, the following utilities are installed. <ul style="list-style-type: none"> <li>• Status Monitor (<a href="#">page 7-19</a>)</li> <li>• Scan Destination and Print Box settings (<a href="#">page 7-20</a>, <a href="#">page 7-26</a>)</li> <li>• Configuration (<a href="#">page 7-19</a>)</li> </ul>	<input type="radio"/>
<b>GX DRIVER</b>	Driver for printing files on a computer using the machine. This printer driver enables full use of the machine's features.	<input type="radio"/>
<b>Kyocera TWAIN Driver GX</b>	This driver enables scanning on the machine using a TWAIN-compliant software application.	<input type="radio"/>
<b>Kyocera WIA Driver</b>	WIA (Windows Imaging Acquisition) is a function of Windows that enables reciprocal communication between an imaging device such as a scanner and an image processing software application. An image can be acquired using a WIA-compliant software application, which is convenient when a TWAIN-compliant software application is not installed in the computer.	<input type="radio"/>



### NOTE

- Installation on Windows must be done by a user logged on with administrator privileges.
- Plug and Play is disabled on this device when in Sleep. To continue the installation, press any key on the operation panel to wake the device from Sleep before continuing.
- When connecting the computer (Host PC) connected to the machine via USB to the computer on the network (Client PC) and using the machine as a shared printer, KYOCERA Client Tool needs to be installed on the Host PC.

# Installing Software in Windows

## Express Install

The following procedure is an example for installing the software in Windows 10 using [\[Express Install\]](#).

For details on Custom Installation, refer to the following:

 [Custom Install \(page 2-13\)](#)

### 1 Insert the DVD.

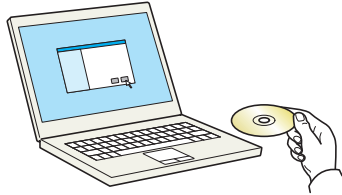

#### NOTE

- Installation on Windows must be done by a user logged on with administrator privileges.
- If the "Welcome to the Found New Hardware Wizard" dialog box displays, select [\[Cancel\]](#).
- If the autorun screen is displayed, click [\[Run Setup.exe\]](#).
- If the user account management window appears, click [\[Yes\]](#) ([\[Allow\]](#)).

### 2 Display the screen.

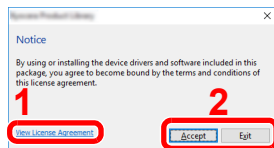

1 Click [\[View License Agreement\]](#) and read the License Agreement.

2 Click [\[Accept\]](#).

### 3 Select [\[Express Install\]](#).

## 4 Install the software.

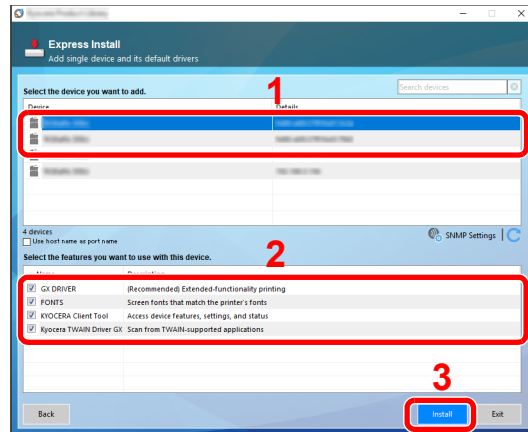

You can also select [[Use host name for port name](#)] and set to use the host name of the standard TCP/IP port. (A USB connection cannot be used.)

When you click [[Install](#)], a screen asking for your cooperation with data collection will be displayed. Select one of the answer choices and click [[OK](#)].



### NOTE

- The machine cannot be detected unless it is on. If the computer fails to detect the machine, verify that it is connected to the computer via a USB cable and that it is turned on and click [C](#) (Reload).
- If the Windows security window appears, click [[Install this driver software anyway](#)].

## 5 Finish the installation.

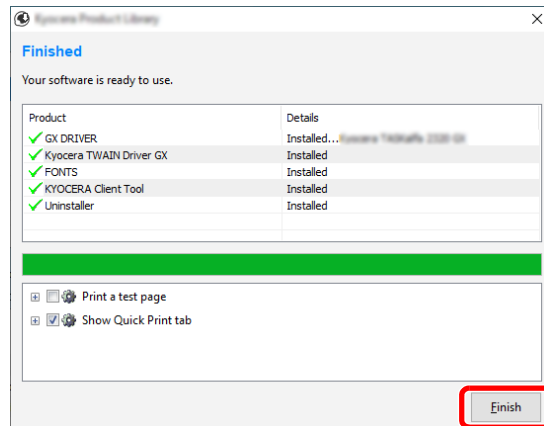

When "Your software is ready to use" appears, you can use the software. To print a test page, click the "Print a test page" checkbox and select the machine.

Click [[Finish](#)] to exit the wizard.

If a system restart message appears, restart the computer by following the screen prompts. This completes the printer driver installation procedure.

If you are installing the TWAIN driver or WIA driver, continue by configuring the [Quick Scan/ TWAIN Settings on page 7-23](#) or [Setting WIA Driver on page 2-20](#).

## Custom Install

The following procedure is an example for installing the software in Windows 10 using [\[Custom Install\]](#).

### 1 Insert the DVD.



#### NOTE

- Installation on Windows must be done by a user logged on with administrator privileges.
- If the "Welcome to the Found New Hardware Wizard" dialog box displays, select [\[Cancel\]](#).
- If the autorun screen is displayed, click [\[Run Setup.exe\]](#).
- If the user account management window appears, click [\[Yes\]](#) ([\[Allow\]](#)).

### 2 Display the screen.

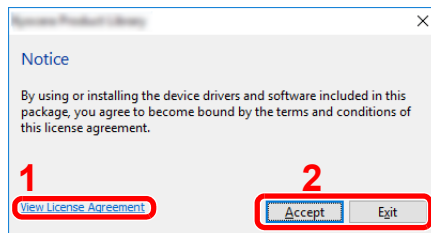

1 Click [\[View License Agreement\]](#) and read the License Agreement.

2 Click [\[Accept\]](#).

### 3 Select [\[Custom Install\]](#).

### 4 Install the software.

1 Select the device to be installed.

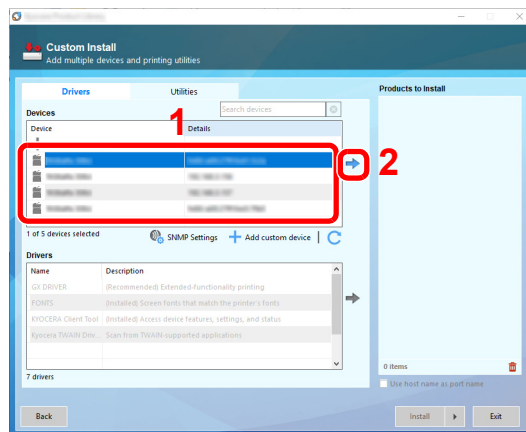

#### NOTE

- The machine cannot be detected unless it is on. If the computer fails to detect the machine, verify that it is connected to the computer via a USB cable and that it is turned on and click [C](#) (Reload).
- If the desired device does not appear, select [\[Add custom device\]](#) to directly select the device.

2 Select the driver to be installed.

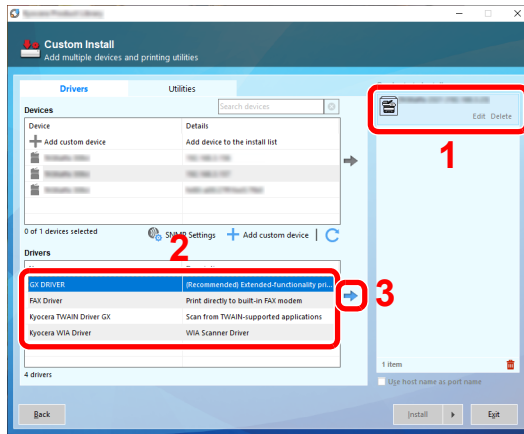

3 Click [Utility] tab and select the utility to be installed.

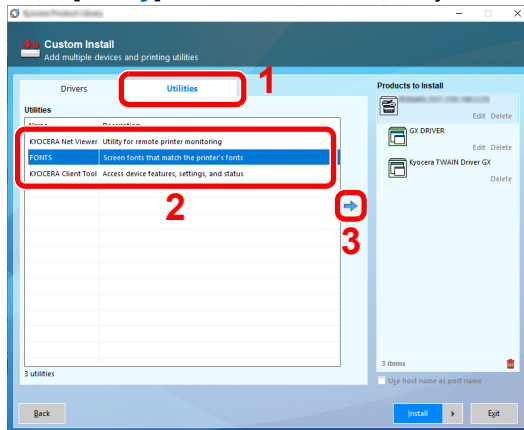

4 Click [Install].

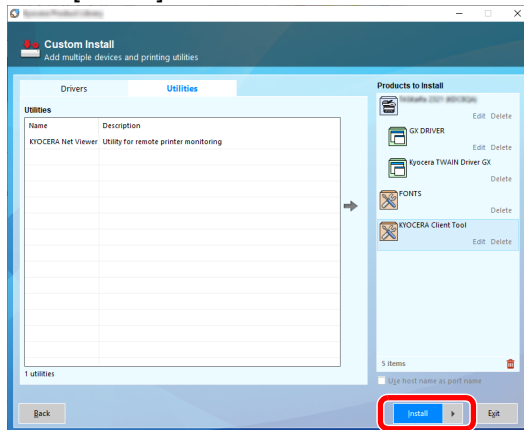

When you click [Install], a screen asking for your cooperation with data collection will be displayed. Select one of the answer choices and click [OK].



## 5 Finish the installation.

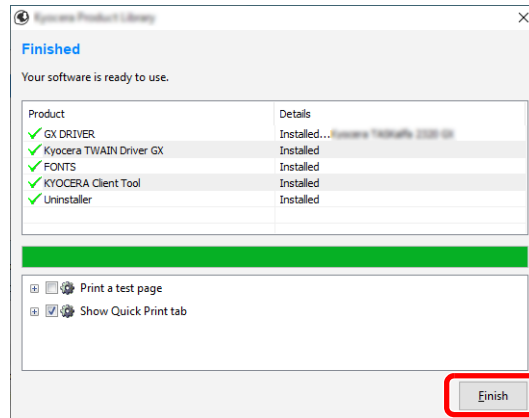

When "Your software is ready to use" appears, you can use the software. To print a test page, click the "Print a test page" checkbox and select the machine.

Click [**Finish**] to exit the wizard.

If a system restart message appears, restart the computer by following the screen prompts. This completes the printer driver installation procedure.

If you are installing the TWAIN driver or WIA driver, continue by configuring the [Quick Scan/TWAIN Settings on page 7-23](#) or [Setting WIA Driver on page 2-20](#).

## Uninstalling the Software

Perform the following procedure to delete the Software from your computer.



### NOTE

Uninstallation on Windows must be done by a user logged on with administrator privileges.

### 1 Display the screen.

Click the search box in the taskbar, and enter "Uninstall Kyocera Product Library" in the search box. Select [[Uninstall Kyocera Product Library](#)] in the search list.

In Windows 8.1, click [[Search](#)] in charms, and enter "Uninstall Kyocera Product Library" in the search box. Select [[Uninstall Kyocera Product Library](#)] in the search list.

### 2 Uninstall the software.

Place a check in the check box of the software to be deleted.

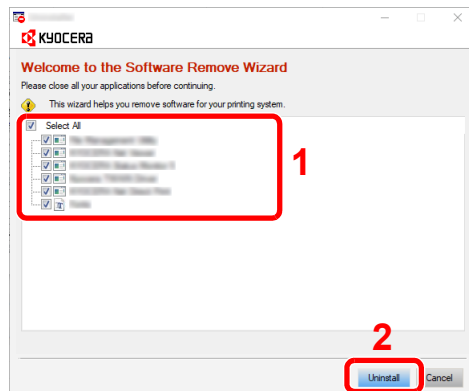

### 3 Finish uninstalling.

If a system restart message appears, restart the computer by following the screen prompts. This completes the software uninstallation procedure.



### NOTE

- The software can also be uninstalled using the Product Library.
- In the Product Library installation screen, click [[Uninstall](#)], and follow the on-screen instructions to uninstall the software.

## Setting the Shared Printer

If the computer connected to the machine (Host PC) via USB is also connected to the computer on the network (Client PC), printing from the computer on the network is enabled by setting the machine as the shared printer.

This section explains how to operate the device on the Host PC and on the Client PC respectively by using the setting example on Windows 10.

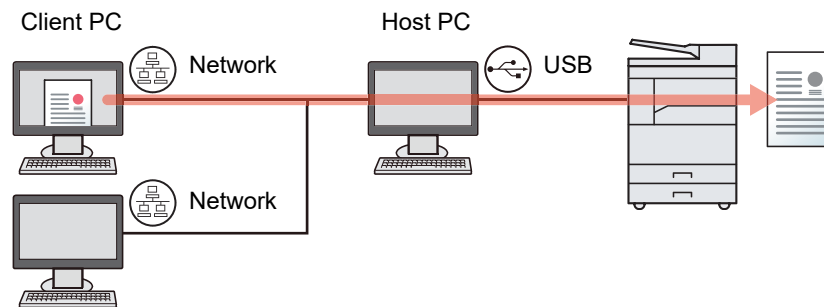

### Sharing Printer on the Host PC

- 1 Click **[Start]** button on the Windows and then select **[Windows System]**, **[Control Panel]**, and **[View devices and printers]**.

In Windows 8.1, select **[Settings]** in charms on Desktop, and select **[Control Panel]**, and then **[Devices and Printers]**.

- 2 Right-click the printer driver icon of the machine, and click the **[Printer properties]** menu of the printer driver.
- 3 Select **[Share this printer]** on the **[Sharing]** tab.
- 4 Click the **[OK]** button.

### Adding the Shared Printer on the Client PC

- 1 Click **[Start]** button on the Windows and then select **[Windows System]**, **[Control Panel]**, and **[View devices and printers]**.

In Windows 8.1, select **[Settings]** in charms on Desktop, and select **[Control Panel]**, and then **[Devices and Printers]**.

- 2 Click **[Add a printer]**.

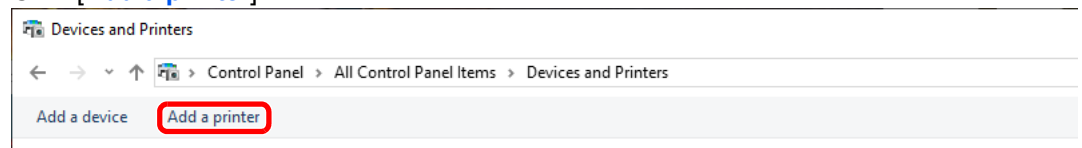

- 3 Click **[Add a network, wireless or Bluetooth printer]**.
- 4 Select the printer added via an operation on the Host PC from the list, and then click **[Next]**.
- 5 Confirm that the printer is added, and then click **[Next]**.
- 6 Print the test page as needed, and then click **[Finish]**.

# Installing Software in Mac Computer

Only the machine's printer functionality can be used by a Mac computer.

## NOTE

- Installation on Mac OS must be done by a user logged on with administrator privileges.
- In the Authenticate screen, enter the name and password used to log in to the operating system.

## 1 Insert the Product Library disc.

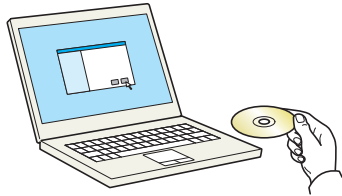

Double-click the [Kyocera] icon.

## 2 Display the screen.

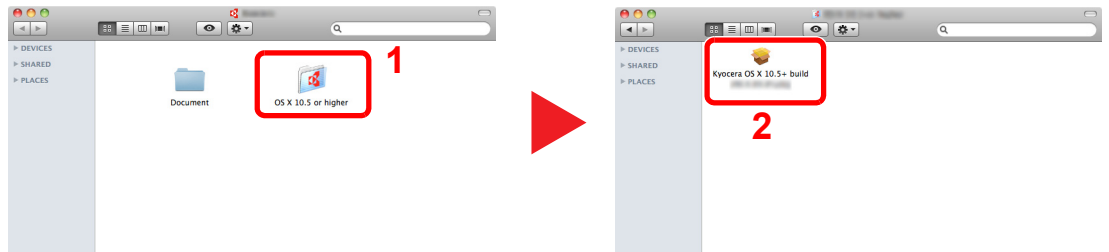

Double-click [OS X 10.5 or higher] and [Kyocera OS X 10.5+].

## 3 Install the Software.

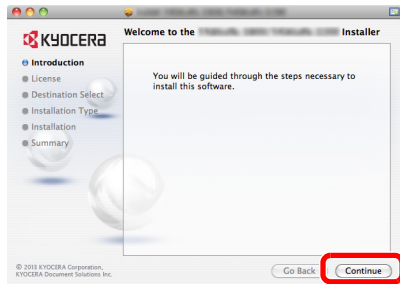

Install the printer driver as directed by the instructions in the installation software.

This completes the printer driver installation.

## KYOCERA Client Tool

KYOCERA Client Tool gives you quick access to common machine features and settings, plus the current status of all supported machines.

You can also use KYOCERA Client Tool to order toner, download printer drivers and open the company website.

KYOCERA Client Tool has the following functions.

Function	Description	Reference Page
<b>Print</b>	Access to printing preferences and machine driver properties.	<a href="#">page 7-17</a>
<b>Device</b>	Configure Status Monitor, Scan Destination, and Print Box settings.	<a href="#">page 7-17</a>
<b>Scan</b>	Configure TWAIN and Quick Scan settings. Scan to PDF, Scan to Email and Scan to Folder can also be executed from this tab.	<a href="#">page 7-18</a>
<b>Maintenance</b>	Order replacement toner, view our web site, and download software.	<a href="#">page 7-18</a>

## Accessing KYOCERA Client Tool

Start KYOCERA Client Tool.

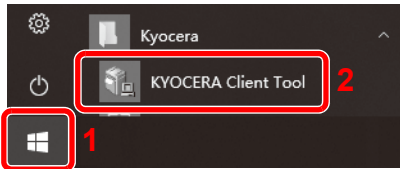

In Windows 8.1, select **[Search]** in charms, **[Apps]**, and then **[KYOCERA Client Tool]**.

## Setting WIA Driver

Register this machine to the WIA Driver. Instructions are based on interface elements as they appear in Windows 10.

### 1 Display the screen.

- 1 Click the search box in the taskbar, and enter "control.exe /name Microsoft.ScannersAndCameras" in the search box. Select [**control.exe /name Microsoft.ScannersAndCameras**] in the search list then the Scanners and Cameras screen appears.

In Windows 8.1, click [**Search**] in charms, and then [**Settings**], and enter "Scanner" in the search box.

Click [**View scanners and cameras**] in the search list then the Scanners and Cameras screen appears.

- 2 Select the same name as this machine from WIA Drivers, and click [**Properties**].

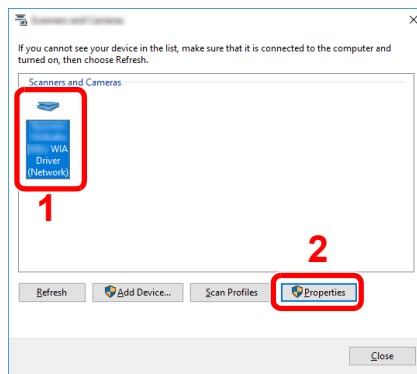

### 2 Configure WIA Driver.

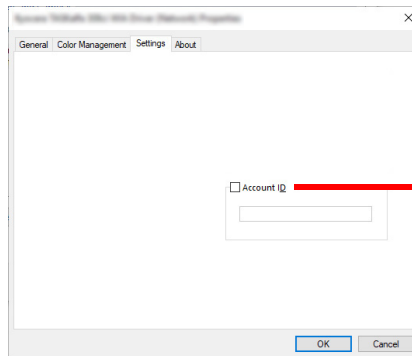

If managing the number of jobs scanned by using WIA with job accounting, select the checkbox beside [**Account ID**], and enter the account ID containing as many as eight digits.

# Administrator User Name and Password

If you are setting a function that requires administrator rights, you must enter your login user name and login password. The factory default login user name and login password are set as shown below.

Login User Name	Login Password
Admin *1	Admin *1

\*1 Upper case and lower case letters are distinguished (case sensitive).

You can change the default login user name and login password. Refer to [Administrator Setting on page 2-21](#).

You will be unable to log in if you forget your login user name or login password.

If job accounting is enabled, you need to enter an account ID. Refer to [Login/Logout on page 8-15](#).

## 1 Enter the login user name.

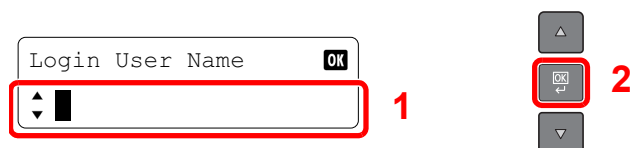

If this screen is displayed during operations, enter the login user name using the numeric keys and press the [OK] key.

 [Character Entry Method \(page 10-4\)](#)

## 2 Enter the login password.



Enter the login password using the numeric keys and press the [OK] key.

 [Character Entry Method \(page 10-4\)](#)

# Administrator Setting

Change the login user name and login password for the administrator.

## 1 Display the screen.

1 Press the [Status/System Menu/Counter] key.



Status/  
System Menu/  
Counter

2 Press the [▲] or [▼] key to select [Admin/Accounting], and press the [OK] key.

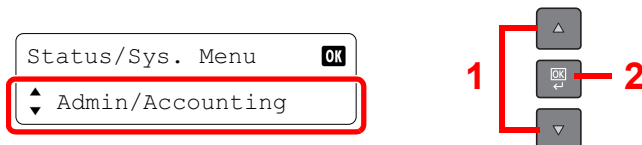

 **NOTE**

If the login user name entry screen appears during operations, log in by referring to [Administrator User Name and Password on page 2-21](#).

The factory default login user name and login password are set as shown below.

Login User Name	Login Password
Admin*1	Admin*1

\*1 Upper case and lower case letters are distinguished (case sensitive).

- 3 Press the [▲] or [▼] key to select [Admin. Setting], and press the [OK] key.



## 2 Configure the settings.

- 1 Press the [OK] key.

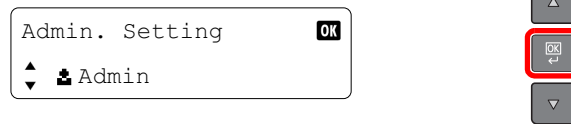

- 2 Enter a new login user name using the numeric keys and press the [OK] key.

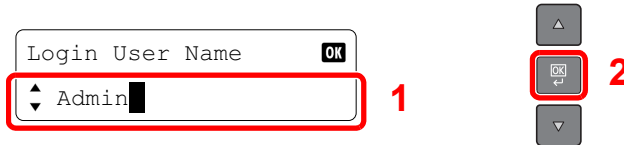

 [Character Entry Method \(page 10-4\)](#)

- 3 Enter a new login password using the numeric keys and press the [OK] key.



- 4 Reenter the same login password for confirmation and press the [OK] key.

- 5 Press the [▲] or [▼] key to select [Yes], and press the [OK] key.

The login user name and login password for the administrator are changed.



# Setting Energy Saver Function

To use the Energy Saver function, configure the following settings:

- [Sleep and Sleep Timer \(page 2-23\)](#)
- [Power Off Timer \(page 2-24\)](#)

## Sleep and Sleep Timer

### Sleep

To enter Sleep, press the **[Energy Saver]** key. All indicators on the operation panel will go out to save power except the **[Energy Saver]** indicators. This status is referred to as Sleep.



If print data is received during Sleep, the print job is performed while the message display remains unlit.

To use the machine, press any key on the operation panel.

The machine will be ready to operate within 11 seconds.

Note that ambient environmental conditions, such as ventilation, may cause the machine to respond more slowly.

### Sleep Timer

Sleep Timer automatically switches the machine into Sleep if left idle for a preset time.

The default preset time is 1 minute.

To change the preset sleep time, refer to [Sleep Timer on page 7-12](#).

Follow the steps below to set the sleep timer for the machine to go into sleep mode when not in use.

#### 1 Display the screen.

- 1 Press the **[Status/System Menu/Counter]** key.



- 2 Press the **[▲]** or **[▼]** key to select **[Common Settings]**, and press the **[OK]** key.

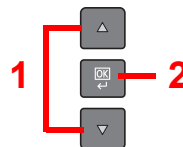
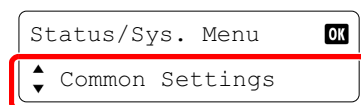

- 3 Press the [▲] or [▼] key to select [Timer Settings], and press the [OK] key.



**NOTE**

If the login user name entry screen appears during operations, log in by referring to [Administrator User Name and Password on page 2-21](#).  
The factory default login user name and login password are set as shown below.

Login User Name	Login Password
Admin*1	Admin*1

\*1 Upper case and lower case letters are distinguished (case sensitive).

- 4 Press the [▲] or [▼] key to select [Sleep Timer], and press the [OK] key.

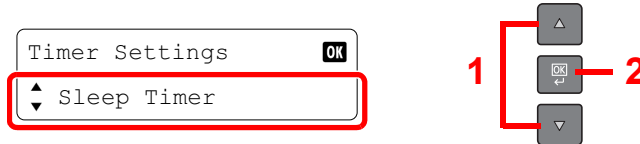

**2 Set the sleep time.**

Use the numeric key or press the [▲] or [▼] key to enter the sleep time, and press the [OK] key.

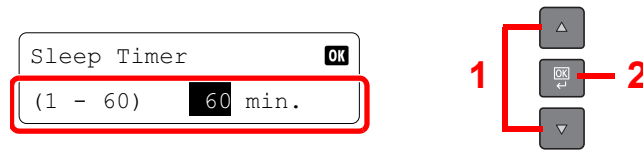

**Power Off Timer**

If the machine is not used while in sleep mode, the power automatically turns off. The Power Off Timer is used to set the time until the power turns off. The factory setting for the time until the power turns off is 1 hour.

To change the preset power off time, refer to [Power Off Rule on page 7-12](#) and [Power Off Timer on page 7-12](#).

To use the Power Off Timer, configure the following settings:

- [Power Off Rule \(page 2-24\)](#)
- [Power Off Timer \(page 2-25\)](#)

**Power Off Rule**

Follow the steps below to set whether the power automatically turns off when not used.

**1 Display the screen.**

- 1 Press the [Status/System Menu/Counter] key.



- 2 Press the [▲] or [▼] key to select [Common Settings], and press the [OK] key.



- 3 Press the [▲] or [▼] key to select [Timer Settings], and press the [OK] key.



**NOTE**

If the login user name entry screen appears during operations, log in by referring to [Administrator User Name and Password on page 2-21](#).  
The factory default login user name and login password are set as shown below.

Login User Name	Login Password
Admin*1	Admin*1

\*1 Upper case and lower case letters are distinguished (case sensitive).

- 4 Press the [▲] or [▼] key to select [Power Off Rule], and press the [OK] key.



- 5 Press the [▲] or [▼] key to select [USB Cable], and press the [OK] key.



**2 Set the power off rule.**

Press the [▲] or [▼] key to select [Off] or [On], and press the [OK] key.

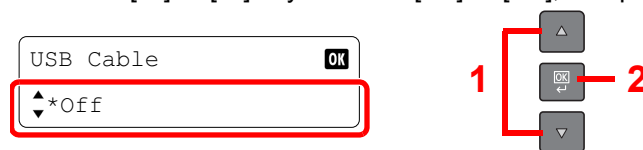

**Power Off Timer**

Follow the steps below to select the length of time before the machine shuts off automatically when not in use.

**1 Display the screen.**

- 1 Press the [Status/System Menu/Counter] key.



- 2 Press the [▲] or [▼] key to select [Common Settings], and press the [OK] key.



- 3 Press the [▲] or [▼] key to select [Timer Settings], and press the [OK] key.



**NOTE**

If the login user name entry screen appears during operations, log in by referring to [Administrator User Name and Password on page 2-21](#).

The factory default login user name and login password are set as shown below.

Login User Name	Login Password
Admin*1	Admin*1

\*1 Upper case and lower case letters are distinguished (case sensitive).

- 4 Press the [▲] or [▼] key to select [Power Off Timer], and press the [OK] key.

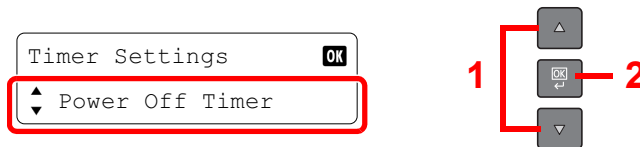

**2 Set the power off time.**

Press the [▲] or [▼] key to select the power off time, and press the [OK] key.

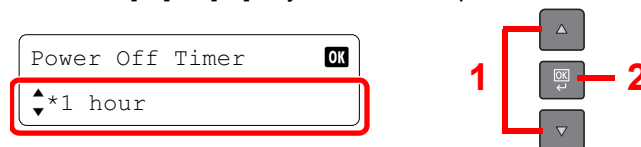

# Checking the Counter

Press the [**Status/System Menu/Counter**] key to check the number of sheets printed and scanned.

## 1 Display the screen.

- 1 Press the [**Status/System Menu/Counter**] key.



- 2 Press the [**▲**] or [**▼**] key to select [Counter], and press the [**OK**] key.

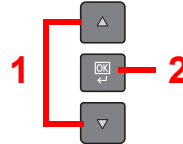
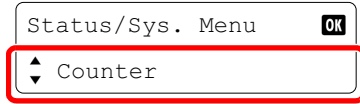

## 2 Check the counter.

Press the [**▲**] or [**▼**] key to select the item you want to check, and press the [**OK**] key.

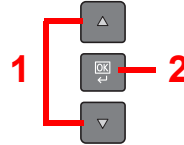
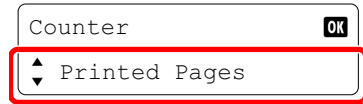

# 3 Preparation before Use

This chapter explains the following operations.

Using the Operation Panel .....	3-2
Operation Panel Keys .....	3-2
Operation Method .....	3-3
Display for Originals and Paper .....	3-4
Loading Paper .....	3-5
Before Loading Paper .....	3-6
Loading in the Cassettes .....	3-7
Loading Paper in the Multi Purpose Tray .....	3-10
Specifying Paper Size and Media Type .....	3-13

# Using the Operation Panel

## Operation Panel Keys

Status/ System Menu/ Counter	Displays the following screens. Status / Report / Counter / System / Admin/ Accounting / Common Settings / Copy / Printer / Adjust/Maint.	Paper Selection	Displays the paper selection screen.	Function Menu	Displays the function menu for copy.
Program	Displays the Program screen.	Zoom	Displays the zoom setting screen.		Increments or decrements numbers, or selects menu in the message display. In addition, moves the cursor when entering the characters
Print Box	Displays the Print Box screen.	Density	Displays the density setting screen.		Finalizes a function or menu, and numbers that have been entered.
Copy	Displays the Copy screen.	Original Image	Displays the original image setting screen.		Returns to the previous display.
Scan	Displays the Scan screen.	Duplex	Displays the duplex setting screen.	Back	
		Combine	Displays the combine setting screen.		
		ID Card Copy	Displays the ID card Copy screen.		

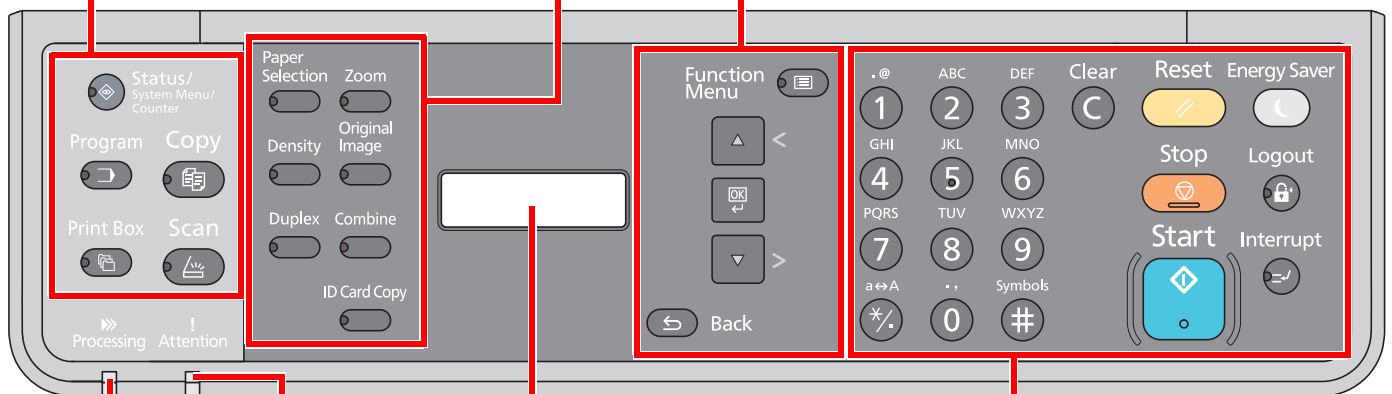

Blinks while printing or sending/receiving.

Lights or blinks when an error occurs and a job is stopped.

Message display. Displays the setting menu, machine status, and error messages.

	Numeric keys. Enter numbers and characters.	Reset	Returns settings to their default states.	Energy Saver	Puts the machine to sleep or wakes it up.
		Stop	Cancels or pauses the job in progress.	Logout	Returns to the account ID entry screen (i.e. log out).
Clear	Clears entered numbers and characters.	Start	Starts copying and scanning operations and processing for setting operations.	Interrupt	Displays the Interrupt Copy screen.

## Operation Method

This section explains how to operate the setting menus on the message display.

### Displaying the Menus and Configuring Settings

Press the [Status/System Menu/Counter] key, [Function Menu] key, or function keys to display the setting menus. Press the [▲] key, [▼] key, [OK] key, or [Back] key to select a menu, and perform settings.

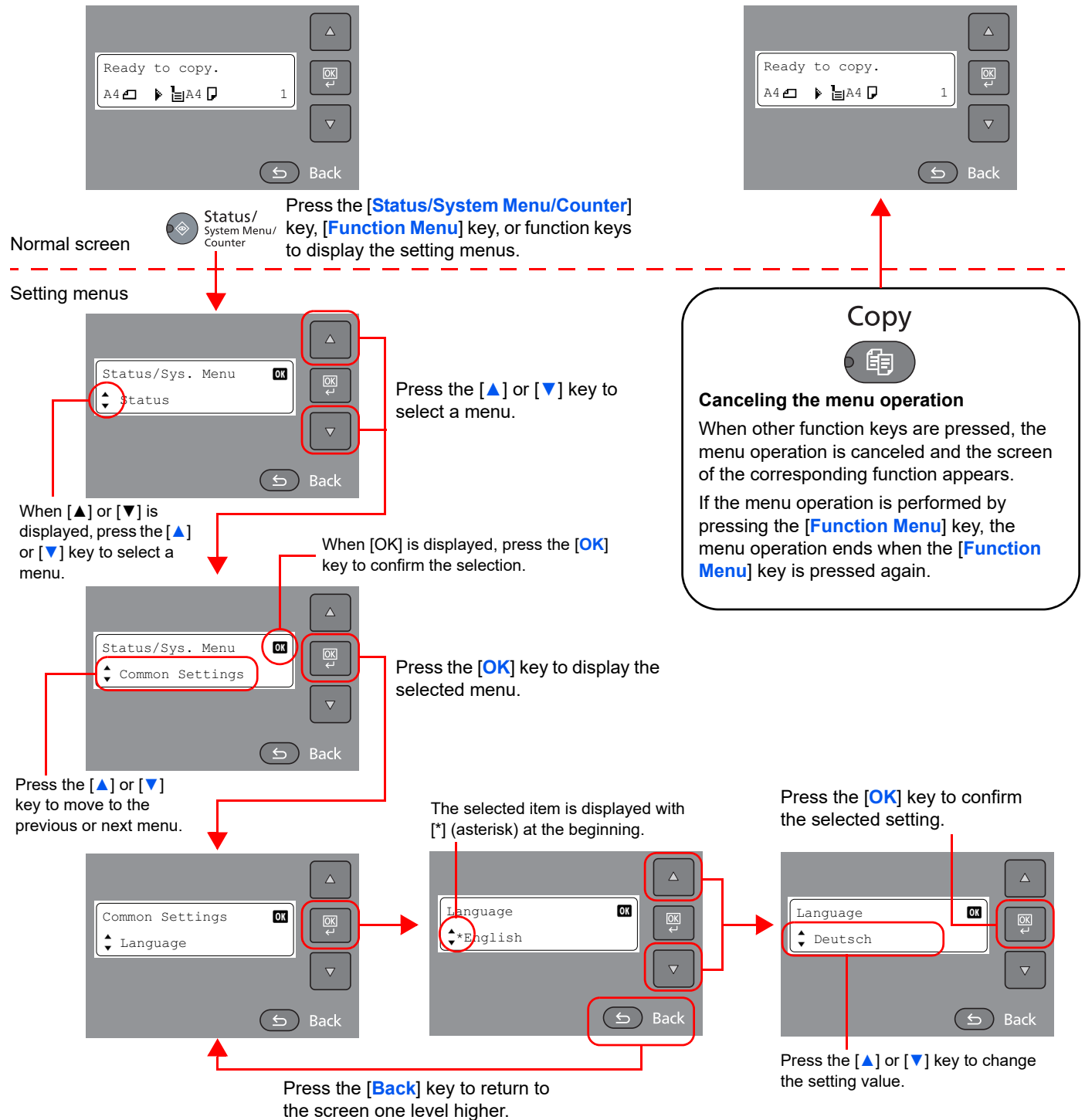



## Display for Originals and Paper

The copy screen displays the selected paper source.

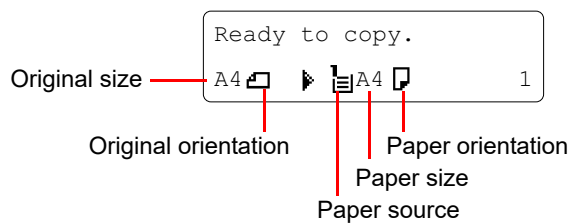

# Loading Paper

Paper can be loaded in the one standard cassette and the multi purpose tray. A paper feeder is also available as an option. (Refer to [Optional Equipment on page 10-2.](#))

For the paper load methods for each cassette, refer to the page below.

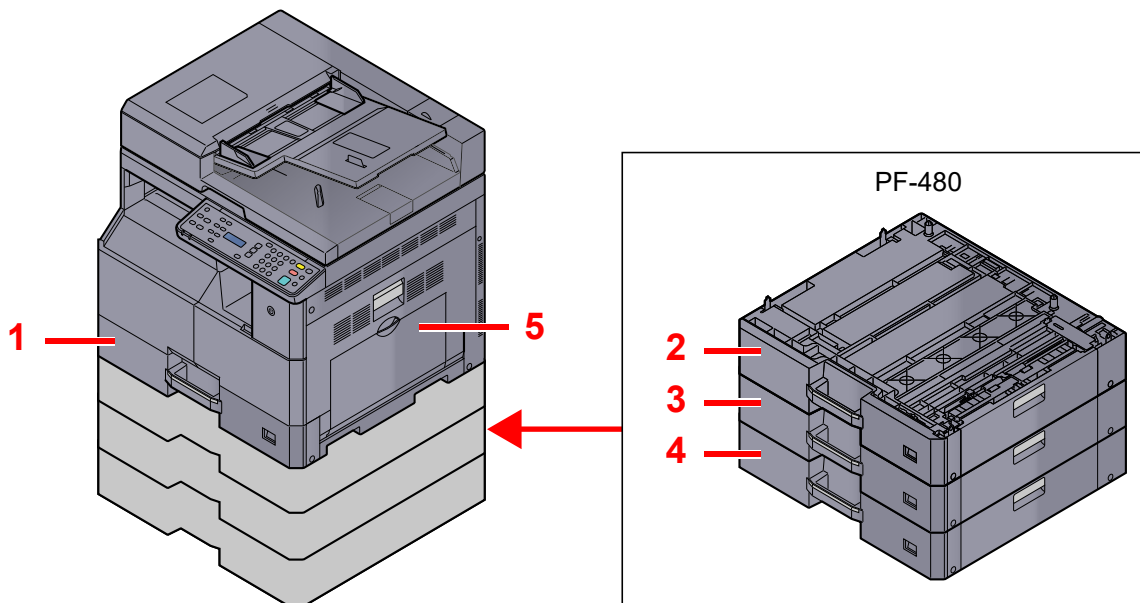

No.	Cassettes	Page
1	Cassette 1	<a href="#">page 3-7</a>
2	Cassette 2	<a href="#">page 3-7</a>
3	Cassette 3	<a href="#">page 3-7</a>
4	Cassette 4	<a href="#">page 3-7</a>
5	Multi Purpose Tray	<a href="#">page 3-10</a>

 **NOTE**

- The number of sheets that can be held varies depending on your environment and paper type.
- You should not use inkjet printer paper or any paper with a special surface coating. (Such paper may cause paper jams or other faults.)

## Before Loading Paper

When you open a new package of paper, fan the sheets to separate them slightly prior to loading in the following steps.

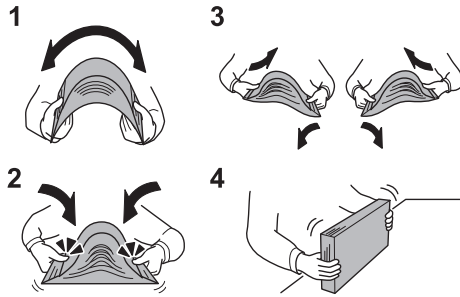

- 1 Bend the whole set of sheets to swell them in the middle.
- 2 Hold the stack at both ends and stretch it while keeping the entire stack swelled.
- 3 Raise the right and left hands alternately to create a gap and feed air between the papers.
- 4 Finally, align the papers on a level, flat table.

If the paper is curled or folded, straighten it before loading. Paper that is curled or folded may cause a jam.

### IMPORTANT

**If you copy onto used paper (paper already used for printing), do not use paper that is stapled or clipped together. This may damage the machine or cause poor image quality.**

### NOTE

- Note that some paper types have a tendency to curl and may jam in the paper eject unit.
- If you use special paper such as letterhead, paper with holes or paper with pre-prints like logo or company name, refer to [Paper on page 10-7](#).

Avoid exposing opened paper to high temperatures and high humidity as dampness can be a cause of problems. Seal any remaining paper after loading in the multi purpose tray or cassettes back in the paper storage bag.

If the machine will not be used for a prolonged period, protect all paper from humidity by removing it from the cassettes and sealing it in the paper storage bag.

## Loading in the Cassettes

The standard cassette can hold plain paper, recycled paper or color paper.

Cassette 1 hold up to 300 sheets of plain paper (80 g/m<sup>2</sup>).

The following paper sizes are supported: A3, B4, A4, A4-R, B5, B5-R, A5-R, Folio, Ledger, Legal, Oficio II, Letter, Letter-R, Statement-R, 8K, 16K, 16K-R, and 216 × 340 mm.

### ✔ IMPORTANT

- When using media types other than plain paper (such as recycled or colored paper), always specify the media type and paper weight settings.

 [Specifying Paper Size and Media Type for the Cassettes \(page 3-13\)](#)  
[Media Type Set. \(Media Type Settings\) \(page 7-10\)](#)

- The cassettes can hold paper with weight between 64 - 105 g/m<sup>2</sup>.
- Do not load thick paper that is heavier than 106 g/m<sup>2</sup> in the cassettes. Use the multi purpose tray for paper that is heavier than 106 g/m<sup>2</sup>.

### 1 Pull the cassette out toward you until it stops.

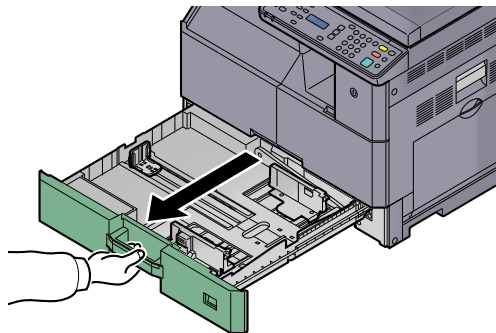

### NOTE

Do not pull out more than one cassette at a time.

### 2 Push down on the cassette base plate and secure it.

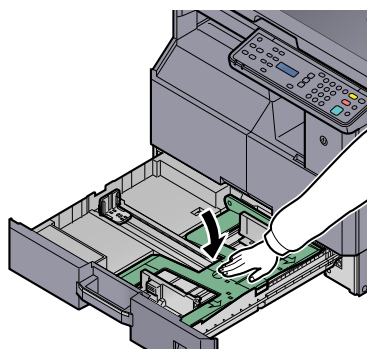

### 3 Adjust the cassette size.

- 1 Holding the paper width adjusting tab, move the paper width guides to fit the paper.

Paper sizes are marked on the cassette.

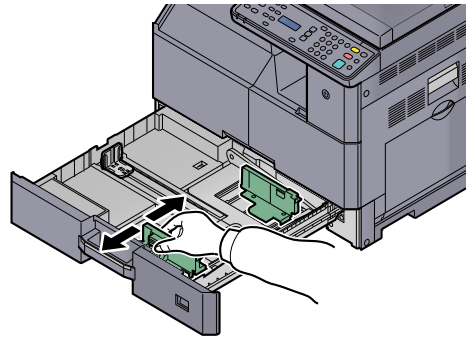

✓ **IMPORTANT**

**Make sure that the width guides are flush against the paper. If there is space between the guides and the paper, set the width guides again.**

- 2 Squeeze the ends of the bottom of the paper length guide and move the guide to fit the length of the paper.

Paper sizes are marked on the cassette.

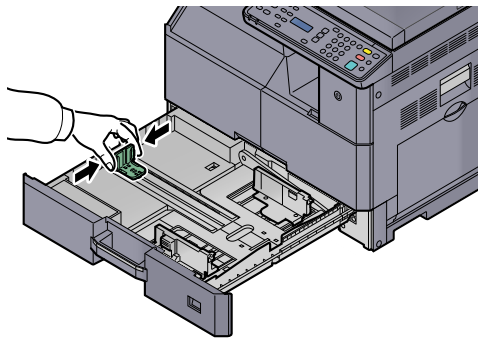

✓ **IMPORTANT**

**Make sure that the length guide is flush against the paper. If there is space between the guide and the paper, set the length guide again.**

### 4 Load paper.

- 1 Set the paper strait from the upper part.

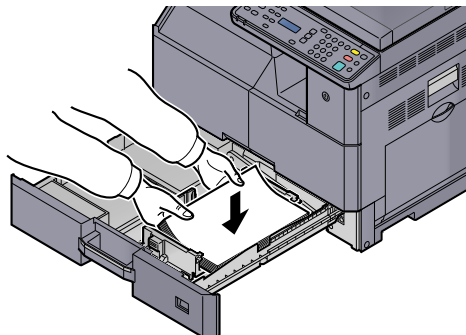

✔ **IMPORTANT**

- Load the paper with the print side facing up.
- After removing new paper from its packaging, fan the paper before loading it in the cassette. (Refer to [Before Loading Paper on page 3-6.](#))
- Before loading the paper, be sure that it is not curled or folded. Paper that is curled or folded may cause paper jams.
- Ensure that the loaded paper does not exceed the level indicator (see illustration below).
- The paper length and width guides must be adjusted to the paper size before loading the paper. Loading the paper without adjusting these guides may cause skewed feeding and paper jams.
- Be sure that the paper length and width guides rest securely against the paper. If there is a gap, readjust the guides to fit the paper.

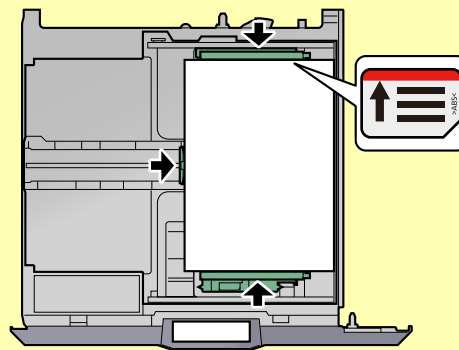

- 2** Insert the appropriate paper size card in the slot to indicate the size of the paper inside.

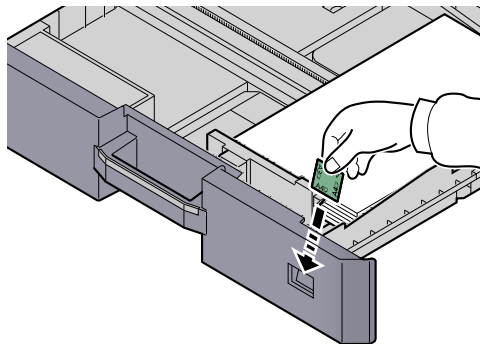

**5 Gently push the cassette back in.**

 **NOTE**

- If the machine will not be used for a prolonged period, protect all paper from humidity by removing it from the cassettes and sealing it in the paper storage bag.
- Select the media type (plain, recycled, etc.) loaded in the cassette.



[Specifying Paper Size and Media Type for the Cassettes \(page 3-13\)](#)

## Loading Paper in the Multi Purpose Tray

The multi purpose tray will hold up to 100 sheets of A4 or smaller plain paper (80 g/m<sup>2</sup>) or up to 25 sheets of plain paper (80 g/m<sup>2</sup>) larger than A4.

The multi purpose tray accepts paper sizes from A3 to A6-R and Hagaki and from Ledger to Statement-R, 8K, 16K and 16K-R. Be sure to use the multi purpose tray when you print on any special paper.

### ✔ IMPORTANT

- When using media types other than plain paper (such as recycled or colored paper), always specify the media type and paper weight settings.

 [Specifying Paper Size and Media Type for the Multi Purpose Tray \(MP Tray Setting\) \(page 3-15\)](#)  
[Media Type Set. \(Media Type Settings\) \(page 7-10\)](#)

- If you are using a paper weight of 106 g/m<sup>2</sup> or more, set the media type to Thick and set the weight of the paper you are using.

The capacity of the multi purpose tray is as follows.

- A4 or smaller plain paper (80 g/m<sup>2</sup>), recycled paper or color paper: 100 sheets
- B4 or larger plain paper (80 g/m<sup>2</sup>), recycled paper or color paper: 25 sheets
- Hagaki: 15 sheets
- OHP film: 25 sheets
- Envelope DL, Envelope C4, Envelope C5, Envelope #10, Envelope #9, Envelope #6, Monarch, Youkei 4, Youkei 2: 5 sheets

### NOTE

- When you load custom size paper, enter the paper size by referring to [Specifying Paper Size and Media Type for the Multi Purpose Tray \(MP Tray Setting\) on page 3-15](#).
- When you use special paper such as transparencies or thick paper, select the media type by referring to [Specifying Paper Size and Media Type for the Multi Purpose Tray \(MP Tray Setting\) on page 3-15](#).

## 1 Open the multi purpose tray.

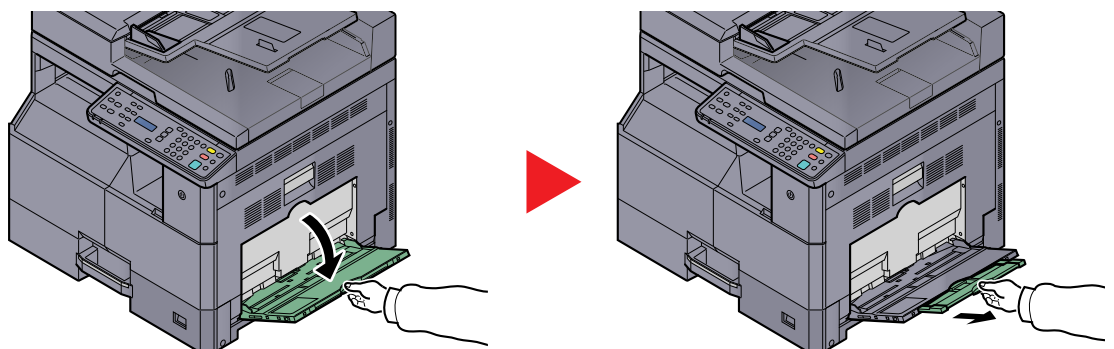

Pull out the MP tray extension to match the paper size. Refer to the label which sealed inside the machine when opening the MP tray.

## 2 Adjust the multi purpose tray size.

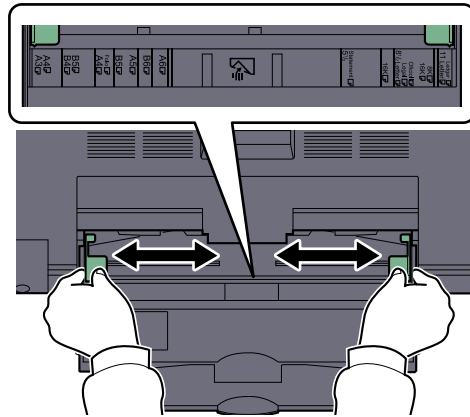

## 3 Load paper.

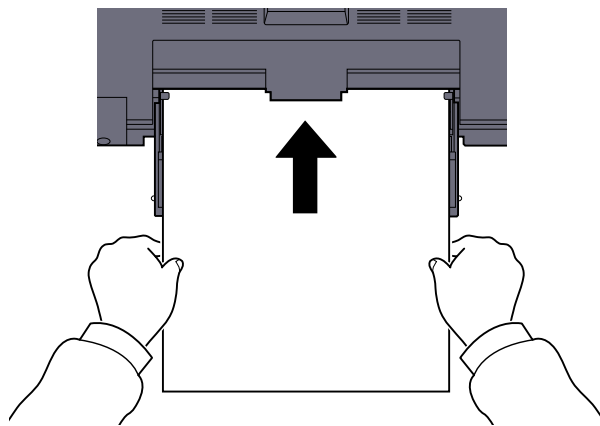

Insert the paper along the paper width guides into the tray until it stops.

After removing new paper from its packaging, fan the paper before loading it in the multi-purpose tray.

 [Before Loading Paper \(page 3-6\)](#)

### IMPORTANT

- When loading the paper, keep the print side facing down.
- Curled paper must be uncurled before use.
- Straighten the top edge if it is curled.
- When loading paper into the multi purpose tray, check that there is no paper left over in the tray from a previous job before loading the paper. If there is just a small amount of paper left over in the multi purpose tray and you want to add more, first remove the left-over paper from the tray and include it with the new paper before loading the paper back into the tray.
- If there is a gap between the paper and the paper width guides, readjust the guides to fit the paper in order to prevent skewed feeding and paper jams.



## When you load envelopes or cardstock in the multi purpose tray

Load the paper with the print side facing down. For the procedure for printing, refer to the **Printer Driver User Guide**.

Example: When printing the address.

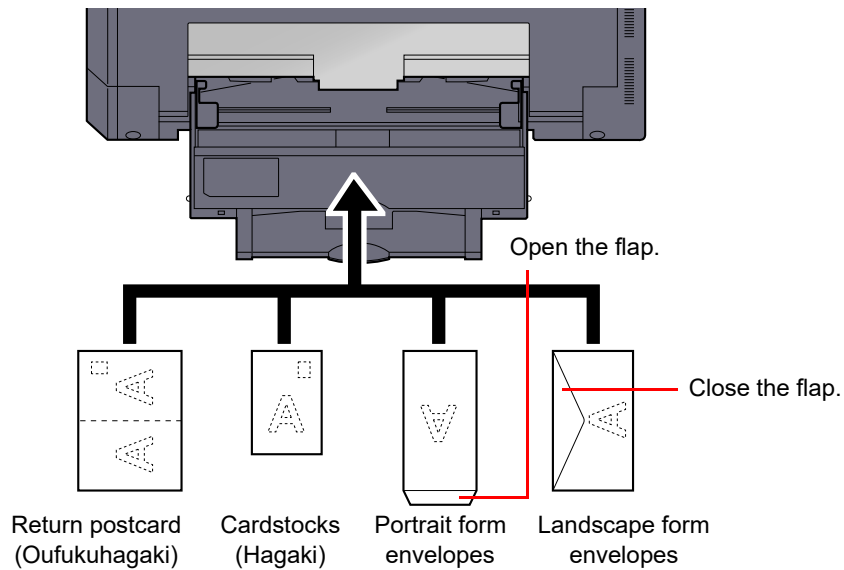

### ✔ IMPORTANT

- Use unfolded return postcard (Oufukuhagaki).
- How to load envelopes (orientation and facing) will differ depending on the type of envelope. Be sure to load it in correctly, otherwise printing may be done in the wrong direction or on the wrong face.

### 👁 NOTE

When you load envelopes in the multi purpose tray, select the envelope type by referring to [Specifying Paper Size and Media Type for the Multi Purpose Tray \(MP Tray Setting\)](#) on page 3-15.

## Specifying Paper Size and Media Type

The default paper size setting for cassette 1 and for the optional paper feeder (cassettes 2 to 4) is [Auto], and the default media type setting is [Plain]. For the multi purpose tray, the default paper size setting is [A4], and the default media type setting is [Plain].

To fix the type of paper to be used in cassettes, specify the paper size and media type setting. (Refer to [Specifying Paper Size and Media Type for the Cassettes on page 3-13](#).) To change the type of paper to be used in the multi purpose tray, specify the paper size and media type setting. (Refer to [Specifying Paper Size and Media Type for the Multi Purpose Tray \(MP Tray Setting\) on page 3-15](#).)

### Specifying Paper Size and Media Type for the Cassettes

To fix the type of paper to be used in cassette 1 or the optional paper feeders (cassettes 2 to 4), specify the paper size. Also, if you use a media type other than plain paper, specify the media type setting.

Selection Item		Selectable Size/Type
Cassette 1 (to 4) Size	Auto	Paper size is automatically detected and selected. <b>Value:</b> Metric, inch
	Standard Sizes	Available options are as follows: <b>Value:</b> A3, A4-R, A4, A5-R, B4, B5-R, B5, Folio, 216 × 340 mm, Ledger, Letter-R, Letter, Legal, Statement-R, Oficio II, 8K, 16K-R, 16K
Cassette 1 (to 4) Type *1		Select the media type. <b>Value:</b> Plain (52 to 105 g/m <sup>2</sup> ), Rough, Vellum (52 to 105 g/m <sup>2</sup> ), Recycled, Preprinted*2, Bond, Color, Prepunched*2, Letterhead*2, Thick (106 to 128 g/m <sup>2</sup> ), High Quality, Custom 1-8

\*1 To change to a media type other than [Plain], refer to [Media Type Set. on page 7-7](#). When the paper weight settings shown below are selected, the media indicated for each setting cannot be selected.

Plain, Preprinted, Recycled, Vellum, Rough, Letterhead, Color, Preprinted, High Quality: [Heavy 1], [Heavy 2] or [Extra Heavy]  
Bond, Thick: [Heavy 2] or [Extra Heavy]  
Custom 1 to 8: [Extra Heavy]

\*2 To print on preprinted or prepunched paper or on letterhead, refer to [SpecialPaper Act. on page 7-8](#).

## 1 Display the screen.

- 1 Press the [Status/System Menu/Counter] key.



- 2 Press the [▲] or [▼] key to select [Common Settings], and press the [OK] key.

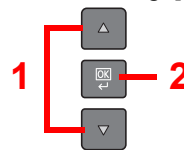
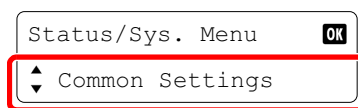

- 3 Press the [▲] or [▼] key to select [Orig./Paper Set.], and press the [OK] key.

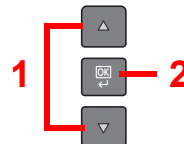
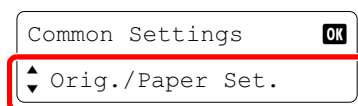

- 4 Press the [▲] or [▼] key to select [Cassette 1 (to 4) Set.], and press the [OK] key.



**NOTE**

[Cassette 2] to [Cassette 4] are shown when the optional paper feeder is installed.

## 2 Specify the paper size.

- 1 Press the [▲] or [▼] key to select [Cassette 1 (to 4) Size], and press the [OK] key.

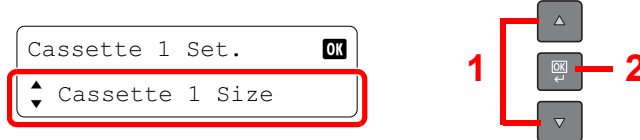

- For automatic detection of the paper size, press the [▲] or [▼] key to select [Auto], and press the [OK] key.

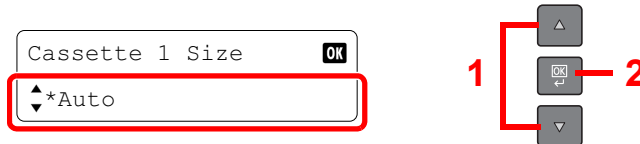

Press the [▲] or [▼] key to select [Metric] or [inch] as the unit, and press the [OK] key.

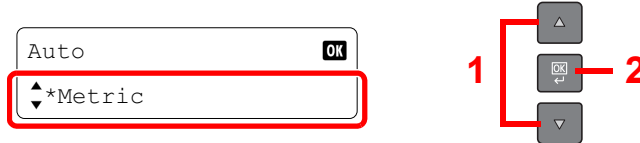

- To select the paper size, press the [▲] or [▼] key to select [Standard Size], and press the [OK] key.

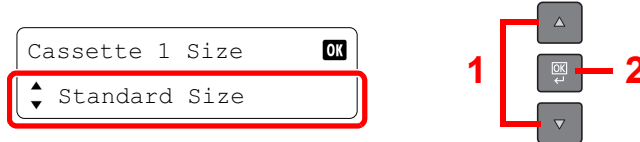

Press the [▲] or [▼] key to select the paper size, and press the [OK] key.

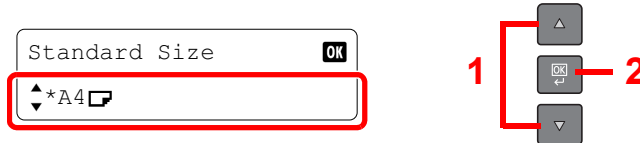

- 2 Press the [Back] key.



## 3 Specify the media type.

- 1 Press the [▲] or [▼] key to select [Cassette 1 (to 4) Type], and press the [OK] key.



- 2 Press the [▲] or [▼] key to select the media type, and press the [OK] key.



## Specifying Paper Size and Media Type for the Multi Purpose Tray (MP Tray Setting)

To change the type of paper to be used in the multi purpose tray, specify the paper size. When using other than a plain paper, specify the media type.

Selection Item		Selectable Size/Type
MP Tray Size	Standard Sizes	Available options are as follows: <b>Value:</b> A3, A4-R, A4, A5-R, A6-R, B4, B5-R, B5, B6-R, Folio, 216 × 340 mm, Ledger, Letter-R, Letter, Legal, Statement-R, Executive, Oficio II, 8K, 16K-R, 16K, ISO B5, Envelope #10, Envelope #9, Envelope #6, Envelope Monarch, Envelope DL, Envelope C5, Envelope C4, Hagaki, Oufukuhagaki, Youkei 4, Youkei 2, Custom* <sup>1</sup>
	Size Entry	Enter the size not included in the standard size. <b>Value</b> <b>Metric</b> X: 148 to 432 mm (in 1 mm increments) Y: 98 to 297 mm (in 1 mm increments) <b>Inch</b> X: 5.83 to 17.00" (in 0.01" increments) Y: 3.86 to 11.69" (in 0.01" increments)
MP Tray Type* <sup>2</sup>		Select the media type. <b>Value:</b> Plain (52 to 105 g/m <sup>2</sup> ), Transparency, Rough, Vellum (52 to 105 g/m <sup>2</sup> ), Labels, Recycled, Preprinted* <sup>3</sup> , Bond, Cardstock, Color, Prepunched* <sup>3</sup> , Letterhead* <sup>3</sup> , Envelope, Thick (106 to 163 g/m <sup>2</sup> ), High Quality, Custom 1-8

\*1 For instructions on how to specify the custom paper size, refer to [Custom PaperSize on page 7-7](#).

\*2 To change to a media type other than [Plain], refer to [Media Type Set. on page 7-7](#).

\*3 To print on preprinted or prepunched paper or on letterhead, refer to [SpecialPaper Act. on page 7-8](#).

### 1 Display the screen.

- 1 Press the [Status/System Menu/Counter] key.



- 2 Press the [▲] or [▼] key to select [Common Settings], and press the [OK] key.



- 3 Press the [▲] or [▼] key to select [Orig./Paper Set.], and press the [OK] key.

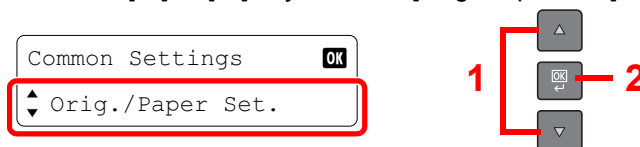

- 4 Press the [▲] or [▼] key to select [MP Tray Set.], and press the [OK] key.

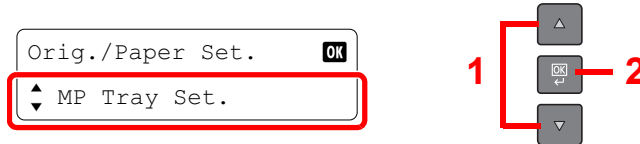

## 2 Specify the paper size.

- 1 Press the [▲] or [▼] key to select [MP Tray Size], and press the [OK] key.



- To select the paper size, press the [▲] or [▼] key to select [Standard Size], and press the [OK] key.



Press the [▲] or [▼] key to select the paper size, and press the [OK] key.



- To enter a size not displayed in the standard sizes, press the [▲] or [▼] key to select [Size Entry], and press the [OK] key.



Use the numeric keys or press the [▲] or [▼] key to enter the paper length, and press the [OK] key.



Use the numeric keys or press the [▲] or [▼] key to enter the paper width, and press the [OK] key.

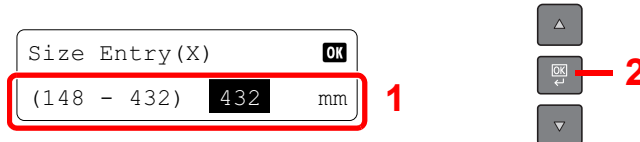

- 2 Press the [Back] key.



## 3 Specify the media type.

- 1 Press the [▲] or [▼] key to select [MP Tray Type], and press the [OK] key.

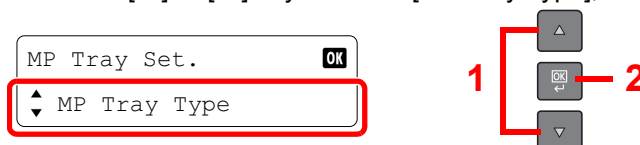

- 2 Press the [▲] or [▼] key to select the media type, and press the [OK] key.

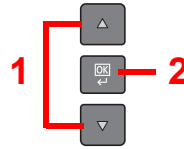
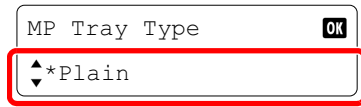

# 4 Printing from PC

This chapter explains the following topics:

Printing from PC .....	4-2
Printer Driver Print Settings .....	4-5
Printer Driver Help .....	4-6
Changing the Default Printer Driver Settings (Windows 10) .....	4-6
Canceling Jobs .....	4-6
Using Print Box .....	4-8
Saving Document to a Print Box .....	4-9
Printing Document from Print Box .....	4-10

# Printing from PC

Follow the steps below to print documents from applications.

## NOTE

- To print the document from applications, install the printer driver on your computer from the supplied Product Library disc.
- In some environments, the current settings are displayed at the bottom of the printer driver.

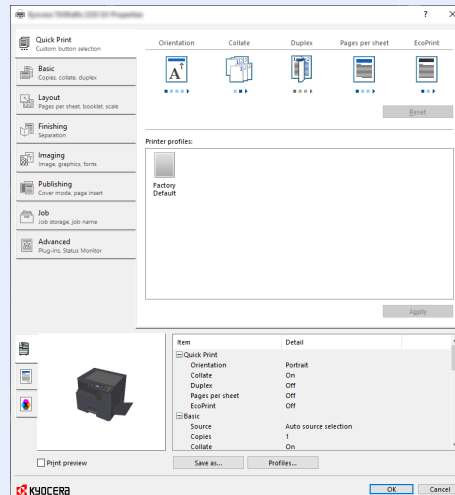

- When printing the cardstock or envelopes, load the cardstock or envelopes before performing the following procedure. (Refer to [When you load envelopes or cardstock in the multi purpose tray on page 3-12.](#))

## 1 Display the screen.

Click [**File**] and select [**Print**] in the application.

## 2 Configure the settings.

- 1 Select the machine from the "Printer" menu and click the [**Properties**] button.

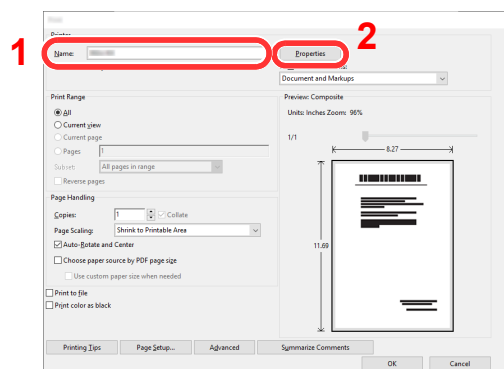



2 Select the [Basic] tab.

3 Click "Print size" menu and select the paper size to use for printing.

To load the paper of size that is not included in print sizes of the machine such as cardstock or envelopes, the paper size needs to be registered.

 [Registering the Original Size \(page 4-3\)](#)

To print on the special paper such as thick paper or transparency, click "Media type" menu and select the media type.

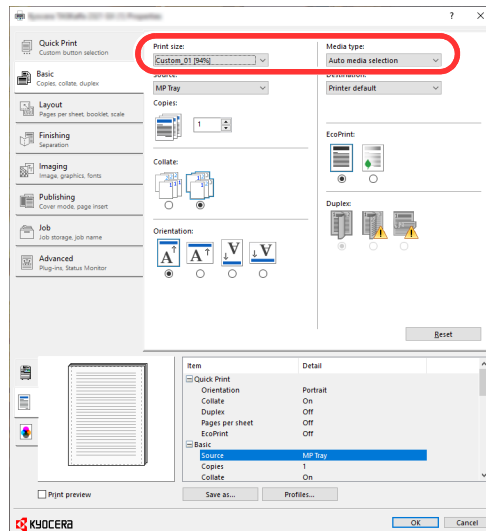

4 Click the [OK] button to return to the Print dialog box.

**3 Click the [OK] button.**

Start printing.

## Registering the Original Size

If you loaded a paper size that is not included in the print sizes of the machine, register the paper size in the [Basic] tab of the print settings screen of the printer driver.

The registered size can be selected from the "Print size" menu.

### NOTE

To execute printing at the machine, set the paper size and type in [Specifying Paper Size and Media Type for the Cassettes on page 3-13](#).

**1 Display the print settings screen.**

**2 Register the paper size.**

1 Click the [Basic] tab.

2 Select [Custom] in the "Print size" menu.

3 Click the [New] button.

4 Enter the name of the paper.

5 Enter the paper size.

- 6 Click the [OK] button.
- 7 In the "Print size" menu, select the paper size (name) that you registered in steps 4 to 7.
- 8 Click [MP tray] in the "Source" menu.
- 9 Select the type of paper in the "Media type" menu.

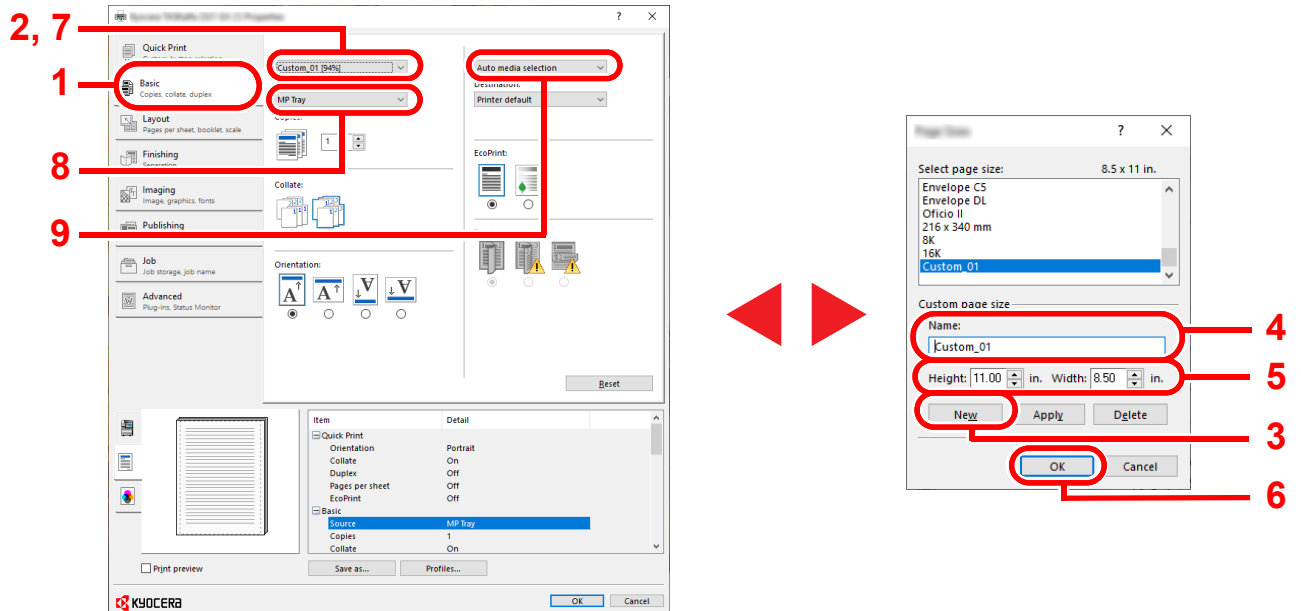

 **NOTE**

If you loaded a postcard or envelope, select [**Cardstock**] or [**Envelope**] in the "Media type" menu.

# Printer Driver Print Settings

The printer driver print settings screen allows you to configure a variety of print-related settings. For more information, refer to the **Printer Driver User Guide** on the Product Library disc.

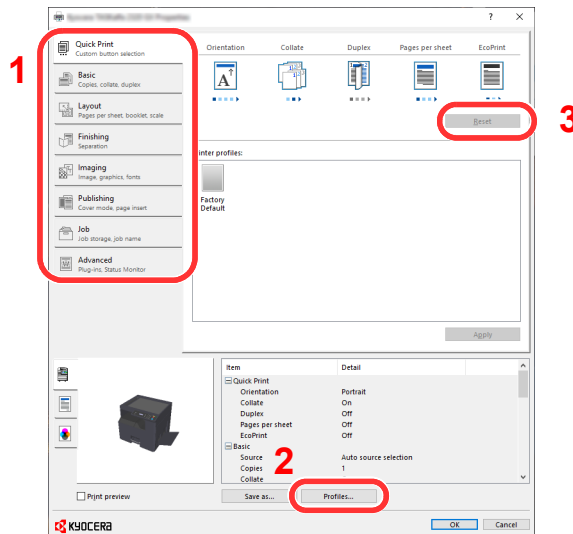

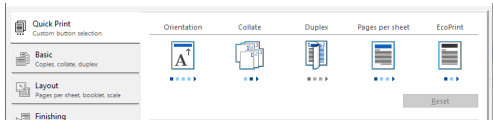
No.	Description
1	<p><b>[Quick Print] tab</b> Provides icons that can be used to easily configure frequently used functions. Each time you click an icon, it changes to an image resembling the print results and applies the settings.</p>  <p><b>[Basic] tab</b> This tab groups basic functions that are frequently used. You can use it to configure the paper size, destination, and duplex printing.</p> <p><b>[Layout] tab</b> This tab lets you configure settings for printing various layouts, including booklet printing, combine mode, poster printing, and scaling.</p> <p><b>[Finishing] tab</b> This tab lets you offset printed media.</p> <p><b>[Imaging] tab</b> This tab lets you configure settings related to the quality of the print results.</p> <p><b>[Publishing] tab</b> This tab lets you create covers and inserts for print jobs and put inserts between sheets of OHP film.</p> <p><b>[Job] tab</b> This tab lets you configure the settings for saving print data in a Print Box. Since saved documents can be printed directly from the machine, this function is convenient when you wish to print a document that you don't want others to see.</p> <p><b>[Advanced] tab</b> This tab lets you configure settings for adding watermarks to print data.</p>
2	<p><b>[Profiles]</b> Printer driver settings can be saved as a profile. Saved profiles can be recalled at any time, so it's a convenient practice to save frequently used settings.</p>
3	<p><b>[Reset]</b> Click to revert settings to their initial values.</p>

## Printer Driver Help

The printer driver includes Help. To learn about print settings, open the printer driver print settings screen and display Help as explained below.

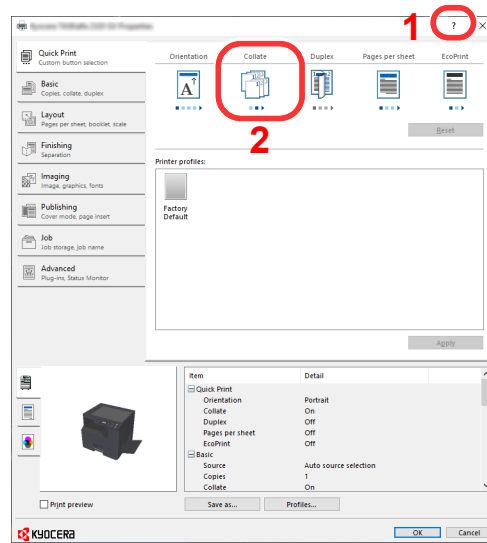

- Click the [?] button in the upper right corner of the screen and then click the item you want to know about.
- Click the item you want to know about and press the [F1] key on your keyboard.

## Changing the Default Printer Driver Settings (Windows 10)

The default printer driver settings can be changed. By selecting frequently used settings, you can omit steps when printing. For the settings, refer to **Printer Driver User Guide**.

- 1 Click [Start] button on the Windows and then select [Windows System], [Control Panel], and [View devices and printers].
- 2 Right-click the printer driver icon of the machine, and click the [Printer properties] menu of the printer driver.
- 3 Click the [Preferences] button on the [General] tab.
- 4 Select the default settings and click the [OK] button.

## Canceling Jobs

You can cancel jobs by pressing the [Stop] key.

Stop



## When there are waiting jobs

[Print Job List] is displayed.

- 1 Press the [▲] or [▼] key to select the job to cancel, and press the [OK] key.



 **NOTE**

Two jobs are displayed in the order of reception by the machine.

- 2 Press the [▲] or [▼] key to select [Cancel Job], and press the [OK] key.



 **NOTE**

Select [Details] and press the [OK] key to show the detailed information of the job.

- 3 Press the [▲] or [▼] key to select [Yes] in the confirmation screen, and press the [OK] key.

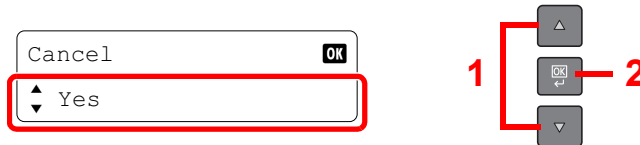

The job is canceled.

 **NOTE**

If a print job remains on a PC, you can cancel the job by following the steps below.

- 1 Double-click the printer icon (  ) displayed on the taskbar at the bottom right of the Windows desktop to display a dialog box for the printer.
- 2 Click the file for which you wish to cancel printing and select [Cancel] from the "Document" menu.

# Using Print Box

Print Box is a function to temporarily save a printer document in the box on a PC and execute printing at the machine. A job is not printed until you operate the machine, and this prevents the printed papers from being taken by someone. With a PIN code assigned to the Print Box, you can further strengthen security.

If you configure settings in the [Print Box] of [Job] tab of the printer driver and then print, the printed data will be saved in the box on the PC and printing can be executed at the machine.

The Print Box can be set in the KYOCERA Client Tool. Refer to [Default Settings on the PC \(KYOCERA Client Tool\) on page 7-16](#).

## Use the Preset Print Box

Save the print data in the preset Print Box. Box 01 is set by default. When selecting Box 01 from the GX Driver and printing, printing can be executed only by selecting Box 01 in the operation panel.

- 1 Select [Box 01] from the GX driver and then execute printing. (Refer to [Saving Document to a Print Box on page 4-9](#).)
- 2 Select [Box 01] to be printed at the machine when needed. (Refer to [Printing Document from Print Box on page 4-10](#).)



## Use Multiple Boxes

A maximum of 10 Print Boxes (Box 01 to 10) can be set by using KYOCERA Client Tool. When connecting the computer (Host PC) connected to the machine via USB to the computer on the network (Client PC) and using the machine as a shared printer, each Client PC can use a different Print Box.

- 1 Preset the Print Box by using KYOCERA Client Tool. (Refer to [Default Settings on the PC \(KYOCERA Client Tool\) on page 7-16](#).)
- 2 Select the Print Box from the Client PC and execute printing. (Refer to [Saving Document to a Print Box on page 4-9](#).)
- 3 A print job is saved in a Print Box in the Host PC.
- 4 Select the Print Box to be printed at the machine when needed. (Refer to [Printing Document from Print Box on page 4-10](#).)

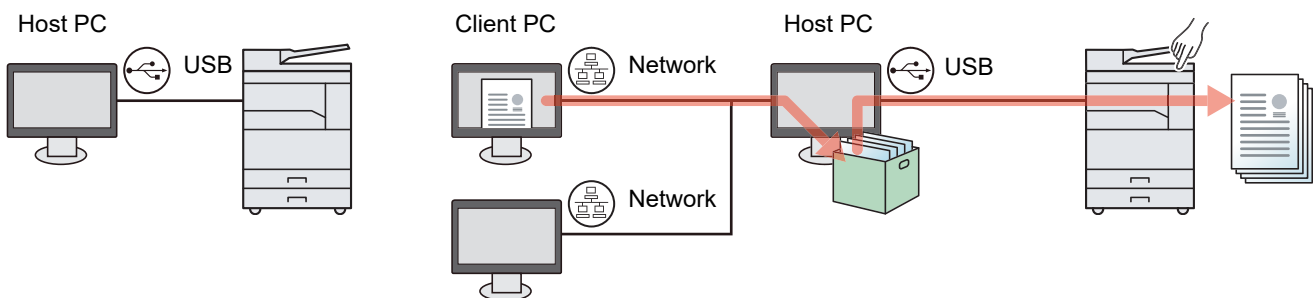

### NOTE

When using the machine as a shared printer, settings must be made for the shared printer. Refer to [Setting the Shared Printer on page 2-17](#).

## Saving Document to a Print Box

Use the procedure below to save a document in the Print Box created on the Host PC. Print Box can be selected from [Box 01] to [Box 10]. To use the other boxes or to change the default box name, configure the settings on KYOCERA Client Tool. Refer to [Default Settings on the PC \(KYOCERA Client Tool\) on page 7-16](#).

In addition, a PIN code can be set for a Print Box. Since the PIN code must be entered when printing at the machine, security is enhanced.

### 1 Start KYOCERA Client Tool on the Host PC.

Refer to [Accessing KYOCERA Client Tool on page 2-19](#).

### 2 Display the screen on your PC.

- 1 Click [File] and select [Print] in the application.
- 2 Select the machine from the "Name" menu and click the [Properties] button.
- 3 Select the [Job] tab.

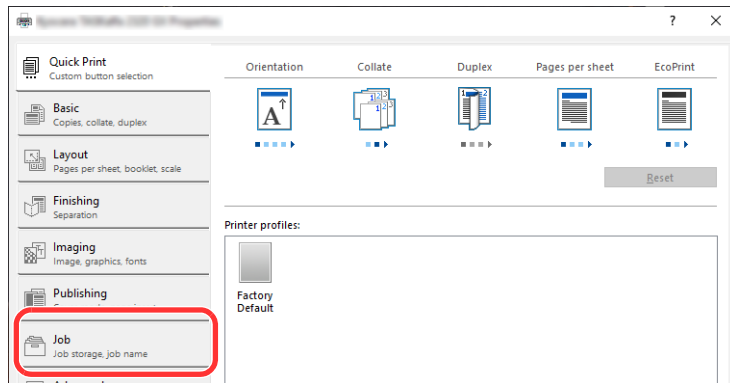

### 3 Configure the settings.

- 1 Select [Print Box] then select the Print Box where the print job should be stored from the [Box 1] to [Box 10].

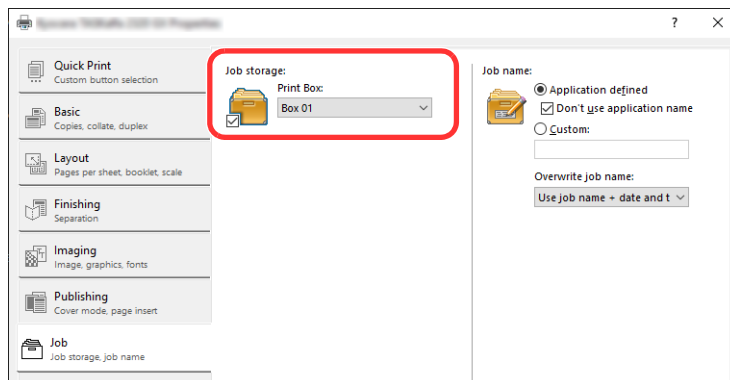

- 2 As necessary, set the job name for the print job.

#### NOTE

Note that the same job name is set and the job is overwritten if [Custom] and [Replace existing file] are set.

### 4 Start printing.

Select [OK] to return to the "Print" screen and click [OK] to start storing.

# Printing Document from Print Box

Print a document saved in a Print Box.

## NOTE

- All documents saved in the selected Print Box are printed.
- KYOCERA Client Tool must be running on the computer from which printing from Print Box is executed. Refer to [Accessing KYOCERA Client Tool on page 2-19](#).
- After being printed, the documents in the Print Box are deleted.

## 1 Start KYOCERA Client Tool on the Host PC.

Refer to [Accessing KYOCERA Client Tool on page 2-19](#).

## 2 Press the [Print Box] key on the machine.

Print Box



## 3 Select the Print Box.

Press the [▲] or [▼] key to select the Print Box.

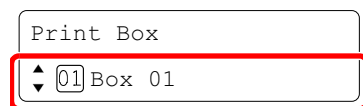

## NOTE

The name set by using KYOCERA Client Tool appears. When using Box 01, the default name (Box 01) is set by KYOCERA Client Tool. When using any of Box 02 to 10, a Box name needs to be set by using KYOCERA Client Tool. If a box with no Box name is set, [-----] appears on the message display. If a document is stored in the box for which no Box name is set, printing from the box is not available.

For details on setting the box name, refer to [Default Settings on the PC \(KYOCERA Client Tool\) on page 7-16](#).

## 4 Press the [Start] key.

Start



Printing starts.

If you have assigned a PIN code to the Box with KYOCERA Client Tool, enter the PIN code using the numeric keys and press the [OK] key.

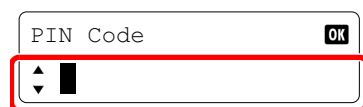



# 5 Operation on the Machine

This chapter explains the following topics:

Loading Originals .....	5-2
Placing Originals on the Platen .....	5-2
Loading Originals in the Document Processor (Option) .....	5-3
Checking the Equipment's Serial Number .....	5-5
Copying .....	5-6
Basic Operation .....	5-6
Interrupt Copy .....	5-7
ID Card Copy .....	5-8
Using Various Functions .....	5-11
Program .....	5-26
Canceling Jobs .....	5-30
Scanning .....	5-31
Scan the Image to the Specified Destination .....	5-33
Scan the Image by Selecting the Destination (Quick Scan) .....	5-35
Scanning using TWAIN .....	5-36
Canceling Jobs .....	5-37

# Loading Originals

## Placing Originals on the Platen

You may place books or magazines on the platen in addition to ordinary sheet originals.

Put the scanning side facedown.

Align it flush against the original size indicator plates with the back left corner as the reference point.

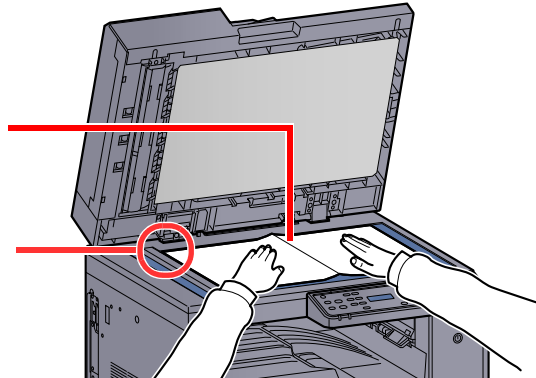

Original size

\* When selecting the copying function

### NOTE

- For details on original size, refer to [Original Size on page 5-20](#).
- For details on original orientation, refer to [Orig. Orientation \(Original Orientation\) on page 5-21](#).

### CAUTION

Do not leave the optional original cover or document processor open as there is a danger of personal injury.

### IMPORTANT

- Do not push the optional original cover or document processor forcefully when you close it. Excessive pressure may crack the platen glass.
- When placing books or magazines on the machine, do so with the optional original cover or document processor in the open position.

## Loading Originals in the Document Processor (Option)

The optional document processor automatically scans each sheet of multiple originals. Both sides of two-sided originals are scanned.

### Originals Supported by the Document Processor

The document processor supports the following types of originals.

Detail	Document Processor
<b>Weight</b>	1-sided: 45 to 120 g/m <sup>2</sup> 2-sided: 50 to 120 g/m <sup>2</sup>
<b>Sizes</b>	Maximum: Ledger/A3 Minimum: Statement-R/A5-R
<b>No. of sheets</b>	Plain paper (50 to 80 g/m <sup>2</sup> ), Colored paper, Recycled paper, High Quality: 50 sheets (Mixed size originals: 30 sheets) Thick paper (120 g/m <sup>2</sup> ): 33 sheets Art paper: 1 sheet

### Originals Not Supported by the Document Processor

Do not use the document processor for the following types of originals.

- Soft originals such as vinyl sheets
- Transparencies such as OHP film
- Carbon paper
- Originals with very slippery surfaces
- Originals with adhesive tape or glue
- Wet originals
- Originals with correction fluid which is not dried
- Irregularly shaped (non-rectangular) originals
- Originals with cut-out sections
- Crumpled paper
- Originals with folds (Straighten the folds before loading. Failure to do so may cause the originals to jam.)
- Originals bound with clips or staples (Remove the clips or staples and straighten curls, wrinkles or creases before loading. Failure to do so may cause the originals to jam.)

## How to Load Originals

### IMPORTANT

- **Before loading originals, be sure that there are no originals left on the original eject table. Originals left on the original eject table may cause the new originals to jam.**
- **Do not make an impact on the document processor top cover, such as aligning the originals on the top cover. It may cause an error in the document processor.**

## 1 Adjust the original width guides.

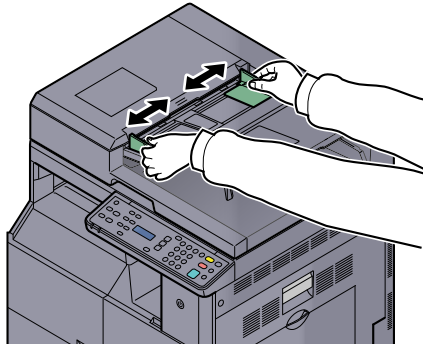

## 2 Place the originals.

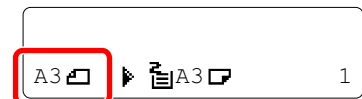
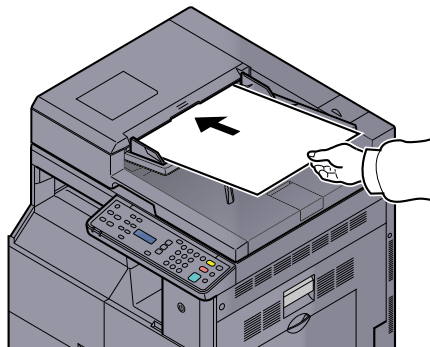

Original size

\* When selecting the copying function

Put the side to be scanned (or the first side of two-sided originals) face-up. Slide the leading edge into the document processor as far as it will go.



### NOTE

- For details on original size, refer to [Original Size on page 5-20](#).
- For details on original orientation, refer to [Orig. Orientation \(Original Orientation\) on page 5-21](#).



### IMPORTANT

- **Confirm that the original width guides exactly fit the originals. If there is a gap, readjust the original width guides. The gap may cause the originals to jam.**

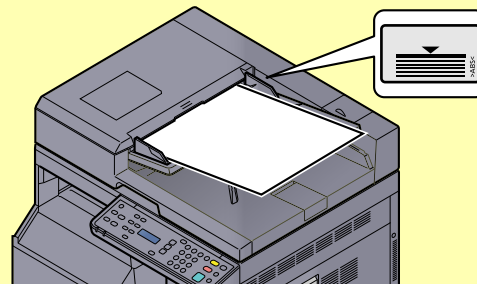

- **Ensure that loaded originals do not exceed the level indicator. Exceeding the maximum level may cause the originals to jam.**
- **Originals with punched holes or perforated lines should be placed in such a way that the holes or perforations will be scanned last (not first).**

## Checking the Equipment's Serial Number

The equipment's serial number is printed in the location shown in the figure.

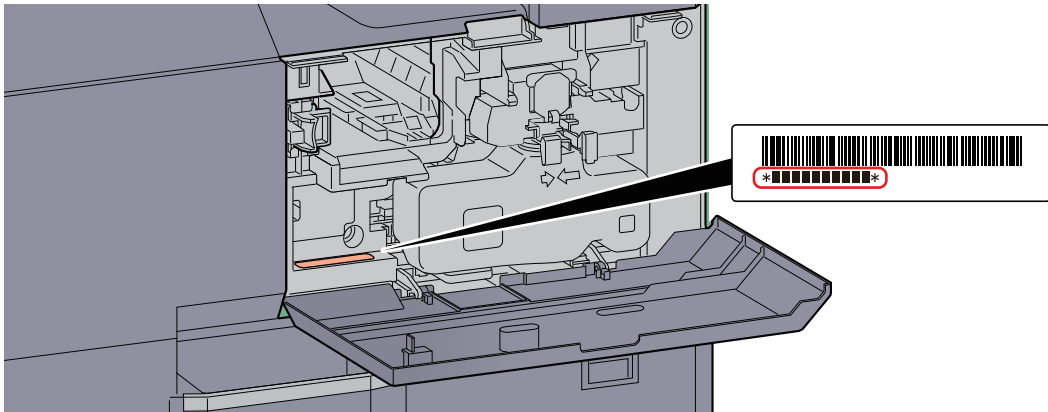

### NOTE

You'll need the equipment's serial number when contacting your Service Representative. Please check the number before contacting your Service Representative.

# Copying

## Basic Operation

Follow the steps as below for basic copying.

### 1 Press the **[Copy]** key.

Copy



### 2 Place the originals.

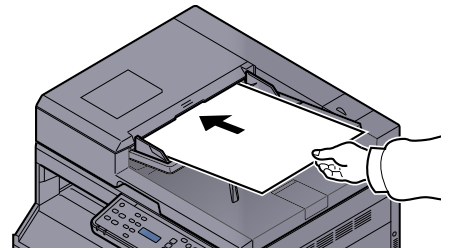
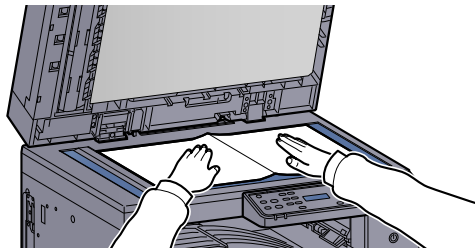

Check the original size and the paper size.

#### NOTE

- For loading instructions, refer to [Loading Originals on page 5-2](#).
- For selecting the paper source, refer to [Paper Selection on page 5-13](#).

### 3 Select the functions.

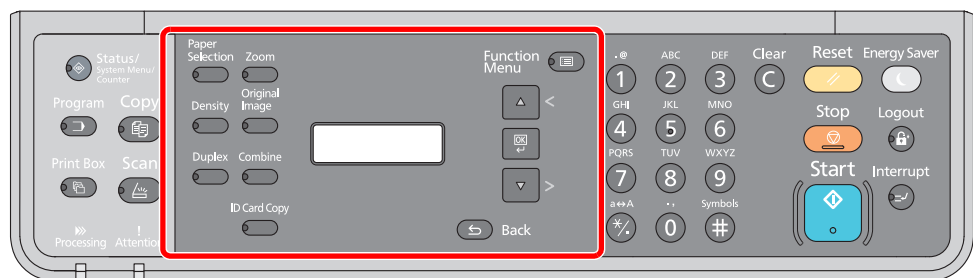

Select the copier functions to use.

 [Using Various Functions \(page 5-11\)](#)

### 4 Use the numeric keys to enter the copy quantity.

Specify the desired number up to 999.

### 5 Press the **[Start]** key.

Start



Copying starts.

## Interrupt Copy

This function allows you to pause the current jobs in progress when you need to make copies immediately. When the interruption copy ends, the machine resumes the paused print jobs.

### NOTE

If the machine is left unused for 60 seconds in interrupt copy mode, interrupt copying is automatically cancelled and printing resumes. You can change the delay until interrupt copying is canceled. Change the delay as required.

 [Interrupt Clear \(page 7-12\)](#)

### 1 Press the **[Interrupt]** key.

Interrupt



The current print job is temporarily interrupted.

### 2 Place the originals onto the machine for interrupt copy.

#### NOTE

For loading instructions, refer to [Loading Originals on page 5-2](#).

### 3 Select the functions.

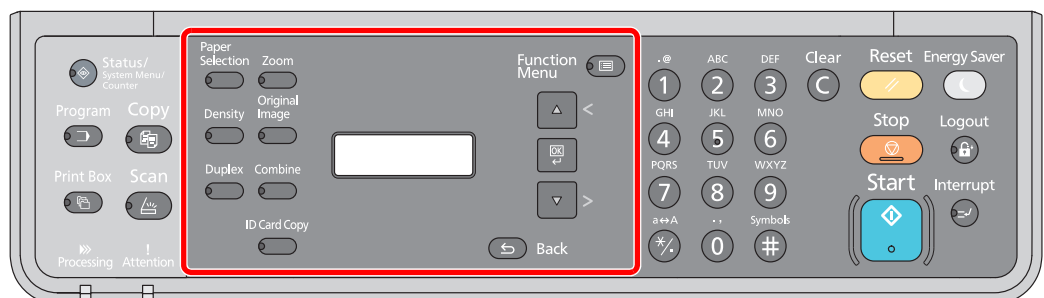

Select the copier functions to use.

 [Using Various Functions \(page 5-11\)](#)

### 4 Press the **[Start]** key.

Start



Interrupt copying starts.

### 5 When interrupt copying ends, press the **[Interrupt]** key.

The machine resumes the paused print jobs.

# ID Card Copy

Use to copy the front and back sides of a license or other ID card on one sheet of paper.

## 1 Configure the settings.

- 1 Press the [ID Card Copy] key.

ID Card Copy



- 2 Press the [▲] or [▼] key to select [On], and press the [OK] key.

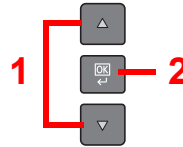
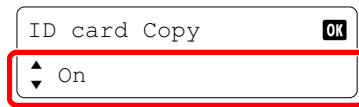

- 3 Press the [▲] or [▼] key to select [Align UpperRight] or [Align Center], and press the [OK] key.

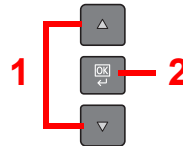
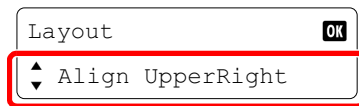

Item	Image	Description
<b>Align UpperRight</b>		Prints the document oriented to the upper right.
<b>Align Center</b>		Prints the document oriented to the center. Even when the ID card is placed askew, the image is corrected so that it is horizontal.



### NOTE

- When [Align Center] is set, the ID card cannot be enlarged or reduced.
- When [Align Center] is set, it takes time for printing to start because skewing correction processing is performed.



## 2 Place the original.

Align with the **ID Card** marks on the Original Size Indicator Plates.

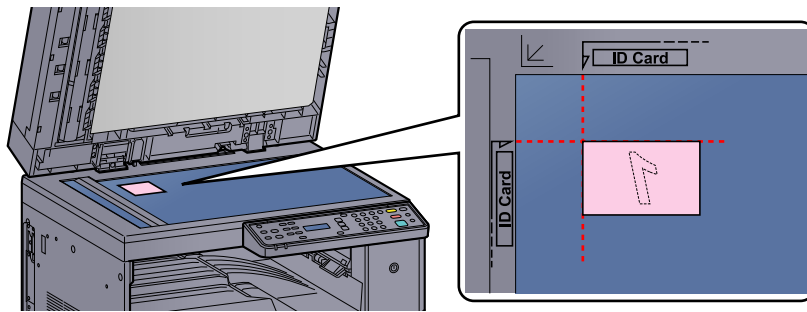

### NOTE

- For loading instructions, refer to [Loading Originals on page 5-2](#).
- When [Align Center] is selected, the ID card that is placed within the A4 size area of the platen is scanned. To perform this function, the original cover or document processor has to be closed.
- If the ID card is scanned with the platen open, skewing correction processing is not performed and the ID card is printed in the same orientation as it is placed. The maximum scannable area is A5-R size.

## 3 Select the functions.

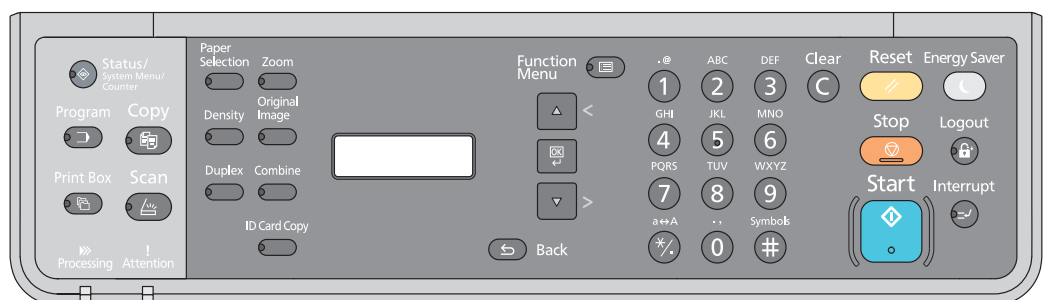

Select the copier functions to use.



[Using Various Functions \(page 5-11\)](#)

## 4 Use the numeric keys to enter the copy quantity.

Refer to [Basic Operation on page 5-6](#).

## 5 Press the [Start] key.

Start



One side of the card is scanned.

## 6 Turn the original over.

Align with the **ID Card** marks on the Original Size Indicator Plates.

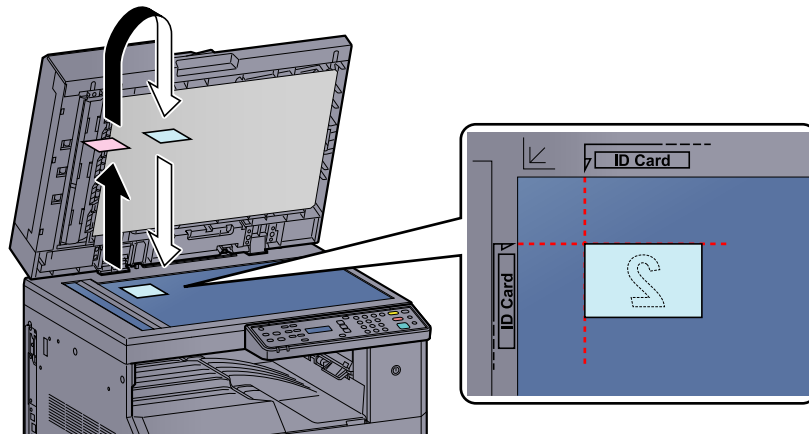

Turn over the card.  
Put it on same place.



Press Start Key.

(Displayed alternately)

## 7 Press the **[Start]** key.

Start



The front and back sides of the card are copied on one sheet of paper.



### NOTE

If you frequently use this function, it will be convenient to register it in a program.



[Program \(page 5-26\)](#)





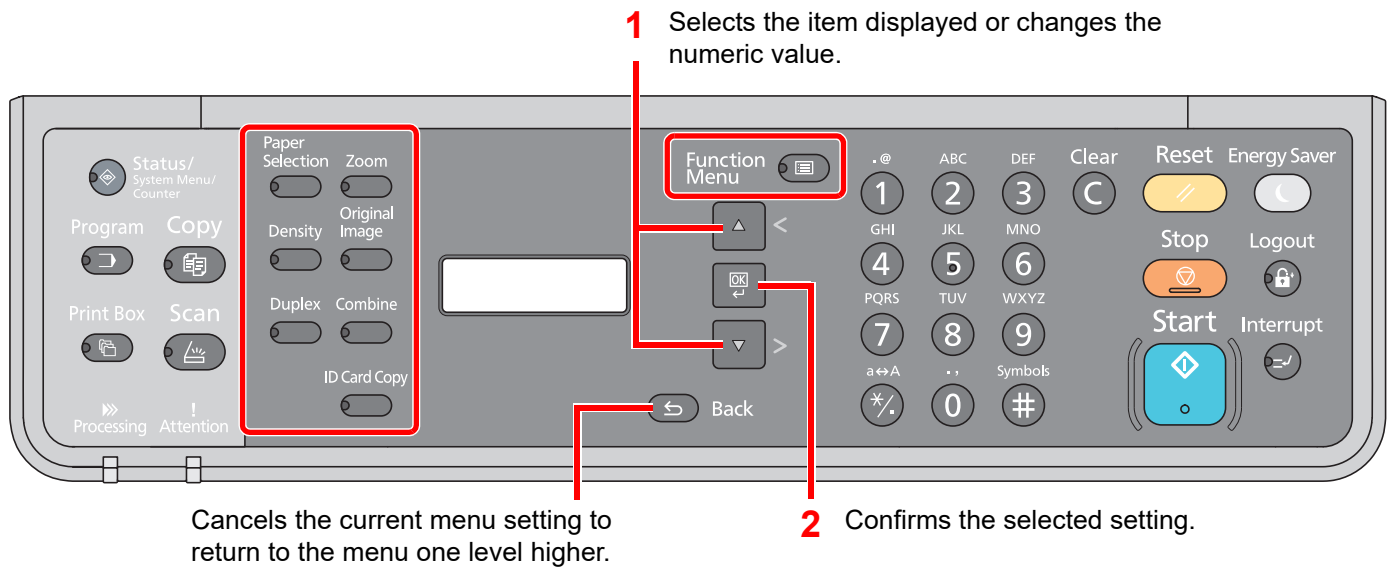

## Using Various Functions

To configure the settings for functions, press the key of the function you want to configure. You can also press the [Function Menu] key to select from other functions displayed on the message display.

 [Operation Method \(page 3-3\).](#)



For details on each function, see the table below.

Key	Function	Description	Reference page
Paper Selection 	<b>Paper Selection</b>	Select the cassette or multi-purpose tray that contains the required paper size.	<a href="#">page 5-13</a>
Zoom 	<b>Zoom</b>	Adjusts the zoom to reduce or enlarge the image.	<a href="#">page 5-14</a>
Density 	<b>Density</b>	Adjust density.	<a href="#">page 5-15</a>
Original Image 	<b>Original Image</b>	Select original image type.	<a href="#">page 5-15</a>
Duplex 	<b>Duplex<sup>*1</sup></b>	Prints 1-sided or open book originals to 2-sided, or 2-sided or open book originals to 1-sided.	<a href="#">page 5-15</a>
Combine 	<b>Combine</b>	Combines 2 or 4 original sheets into 1 printed page.	<a href="#">page 5-18</a>
ID Card Copy 	<b>ID card Copy</b>	Use to copy the front and back sides of a license or other ID card on one sheet of paper.	<a href="#">page 5-8</a>

\*1 The optional duplex unit and document processor are required for some of the duplex modes.

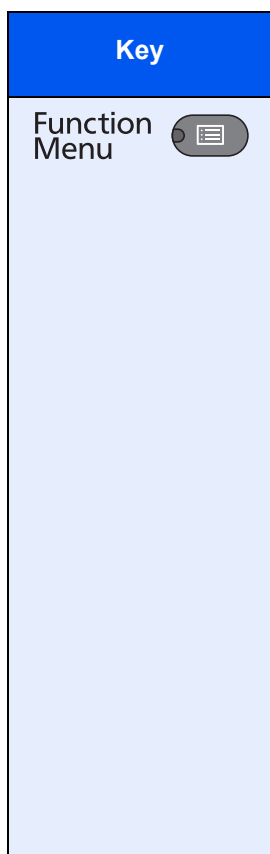

Function	Description	Reference page
<b>Collate/Offset</b>	Offsets the output by page or set.	<a href="#">page 5-20</a>
<b>Original Size</b>	Specify the original size to be scanned.	<a href="#">page 5-20</a>
<b>Orig. Orientation</b>	Select the orientation of the original document top edge to scan correct direction.	<a href="#">page 5-21</a>
<b>Mixed Size Orig.*<sup>1</sup></b>	Scans all sheets in the document processor, even if they are of different sizes.	<a href="#">page 5-22</a>
<b>EcoPrint</b>	Saves toner when printing.	<a href="#">page 5-22</a>
<b>Backgrnd Density</b>	Removes dark background from originals, such as newspapers.	<a href="#">page 5-22</a>
<b>Margin</b>	Adds margin (white space) when printing to allow you to bound copies.	<a href="#">page 5-23</a>
<b>Border Erase</b>	Erases black borders around original when printing.	<a href="#">page 5-24</a>
<b>Continuous Scan</b>	Scans a large number of originals in separate batches and then produce as one job.	<a href="#">page 5-25</a>
<b>Auto Rotation</b>	Rotates image 90 degrees when original and paper source sizes are the same, but their orientation is different.	<a href="#">page 5-25</a>
<b>File Name Entry</b>	Adds a file name.	<a href="#">page 5-25</a>

\*1 The optional document processor is required.

## Paper Selection

Select the cassette or multi-purpose tray that contains the required paper size.



### NOTE

Specify in advance the size and type of the paper loaded in the cassette (refer to [Specifying Paper Size and Media Type on page 3-13](#)).

Item	Value	Description
<b>Auto</b>		The paper matching the size of the original is selected automatically.
<b>Cassette 1 (to 4) <sup>*1</sup></b>		Feed paper from cassette 1 (to 4).
<b>MP Tray</b>		Feed paper from the multi purpose tray.
<b>MP Tray Set.</b>		Before selecting [MP Tray], you need to select [MP Tray Set.] and specify the paper size and media type.
<b>Standard Size</b>	A3, A4-R, A4, A5-R, A6-R, B4, B5-R, B5, B6-R, Folio, 216 × 340 mm, Ledger, Letter-R, Letter, Legal, Statement-R, Executive, Oficio II, 8K, 16K, 16K-R, ISO B5, Envelope #10, Envelope #9, Envelope #6, Envelope Monarch, Envelope DL, Envelope C5, Envelope C4, Hagaki, Oufukuhagaki, Youkei 4, Youkei 2, Custom <sup>*2</sup>	Select from the standard size.
<b>Size Entry</b>	Set the sizes of [Y] (vertical). Metric: 98 to 297 mm (in 1 mm increments) Inch: 3.86 to 11.69" (in 0.01" increments) Set the sizes of [X] (horizontal). Metric: 148 to 432 mm (in 1 mm increments) Inch: 5.83 to 17.00" (in 0.01" increments)	Enter the size not included in the standard size. <sup>*3</sup> Use the numeric keys or press the [▲] or [▼] key to set the sizes of [Y] (vertical) and press the [OK] key. Set the sizes of [X] (horizontal) as well.
<b>Media Type</b>	Plain, Transparency, Rough, Vellum, Labels, Recycled, Preprinted, Bond, Cardstock, Color, Prepunched, Letterhead, Envelope, Thick, High Quality, Custom 1 to 8	Select the media type. Displayed after [Standard Size] or [Size Entry] is set in [MP Tray Set].

\*1 Cassette 2 to Cassette 4 are displayed when the optional paper feeder is installed.

\*2 For instructions on how to specify the custom paper sizes, refer to [Custom PaperSize on page 7-7](#).

\*3 The input units can be changed in System Menu. For details, refer to [Measurement on page 7-11](#).





### NOTE

- You can conveniently select in advance the size and type of paper that will be used often and set them as default (refer to [Specifying Paper Size and Media Type on page 3-13](#)).
- If the specified size of paper is not loaded in the paper source cassette or multi purpose tray, [Load paper in cassette # (MP tray).] appears. Refer to [Responding to Messages on page 9-11](#).

## Zoom

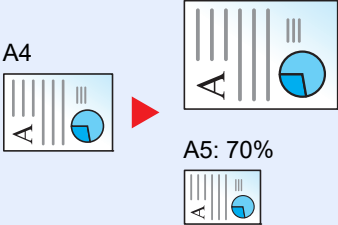
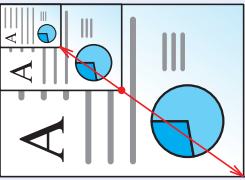
Adjust the zoom to reduce or enlarge the image. The following zoom options are available.

Item	Value	Description									
100%		Reproduces the original size.									
<b>Auto</b>  	A3: 141% A5: 70%	Adjusts the image to match the paper size.									
<b>Standard Zoom</b>	<table border="1"> <tbody> <tr> <td data-bbox="169 698 389 936">Metric</td> <td data-bbox="405 698 699 936">                             100%                              90% Folio&gt;&gt;A4                              75% 11×15" &gt;&gt;A4                              70% A3&gt;&gt;A4 A4&gt;&gt;A5                              50%                              25% Min.                         </td> <td data-bbox="708 698 995 936">                             400% Max.                              200% A5&gt;&gt;A3                              141% A4&gt;&gt;A3 A5&gt;&gt;A4                              127% Folio&gt;&gt;A3                              106% 11 × 15"&gt;&gt;A3                         </td> </tr> <tr> <td data-bbox="169 936 389 1173">Metric (Asia Pacific)</td> <td data-bbox="405 936 699 1173">                             100%                              86% A3&gt;&gt;B4 A4&gt;&gt;B5                              81% B4&gt;&gt;A4 B5&gt;&gt;A5                              70% A3&gt;&gt;A4 B4&gt;&gt;B5                              50%                              25% Min.                         </td> <td data-bbox="708 936 995 1173">                             400% Max.                              200% A5 &gt;&gt; A3                              141% A4&gt;A3 B5&gt;B4                              122% A4&gt;&gt;B4 A5&gt;&gt;B5                              115% B4&gt;&gt;A3 B5&gt;&gt;A4                         </td> </tr> <tr> <td data-bbox="169 1173 389 1397">Inch</td> <td data-bbox="405 1173 699 1397">                             100%                              78% Legal&gt;&gt;Letter                              77% Ledger&gt;&gt;Legal                              64% Ledger&gt;&gt;Letter                              50% Ledger&gt;&gt;STMT                              25% Min.                         </td> <td data-bbox="708 1173 995 1397">                             400% Max.                              200% STMT&gt;&gt;Ledger                              154% STMT&gt;&gt;Legal                              129% Letter&gt;Ledger                              121% Legal&gt;&gt;Ledger                         </td> </tr> </tbody> </table>	Metric	100% 90% Folio>>A4 75% 11×15" >>A4 70% A3>>A4 A4>>A5 50% 25% Min.	400% Max. 200% A5>>A3 141% A4>>A3 A5>>A4 127% Folio>>A3 106% 11 × 15">>A3	Metric (Asia Pacific)	100% 86% A3>>B4 A4>>B5 81% B4>>A4 B5>>A5 70% A3>>A4 B4>>B5 50% 25% Min.	400% Max. 200% A5 >> A3 141% A4>A3 B5>B4 122% A4>>B4 A5>>B5 115% B4>>A3 B5>>A4	Inch	100% 78% Legal>>Letter 77% Ledger>>Legal 64% Ledger>>Letter 50% Ledger>>STMT 25% Min.	400% Max. 200% STMT>>Ledger 154% STMT>>Legal 129% Letter>Ledger 121% Legal>>Ledger	Reduces or enlarges at preset magnifications. Press the [▲] or [▼] key to select the desired magnification.
Metric	100% 90% Folio>>A4 75% 11×15" >>A4 70% A3>>A4 A4>>A5 50% 25% Min.	400% Max. 200% A5>>A3 141% A4>>A3 A5>>A4 127% Folio>>A3 106% 11 × 15">>A3									
Metric (Asia Pacific)	100% 86% A3>>B4 A4>>B5 81% B4>>A4 B5>>A5 70% A3>>A4 B4>>B5 50% 25% Min.	400% Max. 200% A5 >> A3 141% A4>A3 B5>B4 122% A4>>B4 A5>>B5 115% B4>>A3 B5>>A4									
Inch	100% 78% Legal>>Letter 77% Ledger>>Legal 64% Ledger>>Letter 50% Ledger>>STMT 25% Min.	400% Max. 200% STMT>>Ledger 154% STMT>>Legal 129% Letter>Ledger 121% Legal>>Ledger									
<b>Zoom Entry</b>  	25 to 400% (in 1% increments)	Manually reduces or enlarges the original image in 1% increments between 25% and 400%. Use the numeric keys or press the [▲] or [▼] key to enter the any magnification.  <a href="#">Character Entry Method (page 10-4)</a>									

## Density

Adjust density.

Press the [▲] or [▼] key to select [Darker +3] to [Lighter -3].



## Original Image

Select original image type.

Item	Description
<b>Text+Photo</b>	Best for mixed text and photo documents.
<b>Photo</b>	Best for photos taken with a camera.
<b>Text</b>	Sharply renders pencil text and fine lines.

## Duplex

Produces two-sided copies.

You can also create single-sided copies from two-sided originals or originals with facing pages such as books. The following modes are available.

### One-sided to Two-sided

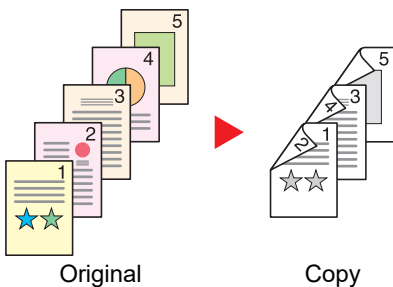

Produces two-sided copies from one-sided originals. In case of an odd number of originals, the back side of the last copy will be blank. The optional duplex unit is required.

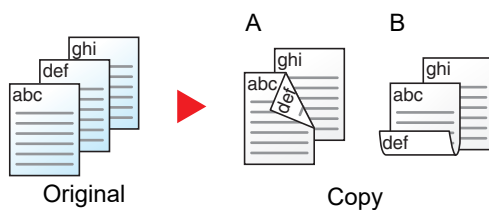

The following binding options are available.

- A Original Left/Right to Binding Left/Right: Images on the second sides are not rotated.
- B Original Left/Right to Binding Top: Images on the second sides are rotated 180 degrees. Copies can be bound on the top edge, facing the same orientation when turning the pages.

### Two-sided to One-sided

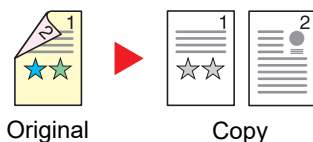

Copies each side of a two-sided original onto two individual sheets. The optional document processor is required.

The following binding options are available.

- Binding Left/Right: Images on the second sides are not rotated.
- Binding Top: Images on the second sides are rotated 180 degrees.

### Two-sided to Two-sided

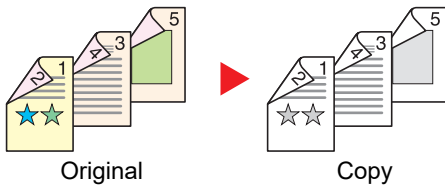

Produces two-sided copies from two-sided originals. The optional duplex unit and document processor are required.

**NOTE**

The paper sizes supported in Two-sided to Two-sided mode are A3, B4, A4, A4-R, B5, B5-R, A5-R, Ledger, Legal, Letter, Letter-R, Executive, Statement-R, Oficio II, 216 × 340 mm and Folio.

### Book to One-sided

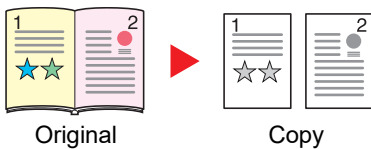

Produces a 1-sided copy of a 2-sided or open book original.

The following binding options are available.

Binding Left: Originals with facing pages are copied from left to right.

Binding Right: Originals with facing pages are copied from right to left.

**NOTE**

- The original sizes supported in Book to One-sided mode are Ledger, Letter-R, A3, A4-R, A5-R, B4, B5-R and 8K.
- The supported paper sizes are A4, B5, Letter and 16K. You may change paper size and reduce or enlarge copy to match that size.

### Book to Two-sided

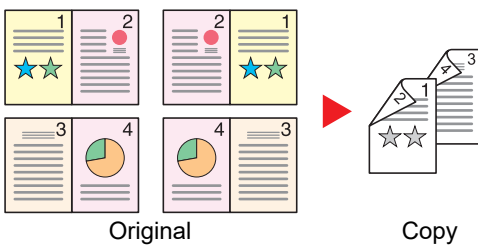

Produces two-sided copies from an open book original with facing pages. The optional duplex unit is required.

**NOTE**

- The original sizes supported in Book to Two-sided mode are A3, B4, A4-R, B5-R, A5-R, Ledger, Letter-R and 8K.
- The supported paper sizes are A4, B5 and Letter.

Prints 1-sided or open book originals to 2-sided, or 2-sided or open book originals to 1-sided. Select the binding orientation for original and finished documents.

Item	Value	Description
1-sided>>1-sided	—	Disables the function.
1-sided>>2-sided	—	Copies the original with the default setting. For the default settings, refer to <a href="#">Function Default on page 7-13</a> .
2-sided>>1-sided		
2-sided>>2-sided		
Book>>1-sided		
Book>>2-sided		



Item		Value	Description
<b>Advanced Duplex</b>		—	Changes the settings.
<b>1-sided&gt;&gt; 2-sided</b>	<b>Finish. Binding</b>	Left/Right, Top	Select the binding orientation of copies, and press the <b>[OK]</b> key.
	<b>Orig. Orientation</b>	Top Edge on Top, Top Edge on Left	Select the orientation of the original document top edge to scan correct direction. Choose orientation of the originals, either [Top Edge on Top] or [Top Edge on Left]. Then press the <b>[OK]</b> key.
<b>2-sided&gt;&gt; 1-sided</b>	<b>Orig. Binding</b>	Left/Right, Top	Select the binding orientation of originals, and press the <b>[OK]</b> key.
	<b>Orig. Orientation</b>	Top Edge on Top, Top Edge on Left	Select the orientation of the original document top edge to scan correct direction. Choose orientation of the originals, either [Top Edge on Top] or [Top Edge on Left]. Then press the <b>[OK]</b> key.
<b>2-sided&gt;&gt; 2-sided</b>	<b>Orig. Binding</b>	Left/Right, Top	Select the binding direction of originals, and press the <b>[OK]</b> key.
	<b>Finish. Binding</b>	Left/Right, Top	Select the binding orientation of copies, and press the <b>[OK]</b> key.
	<b>Orig. Orientation</b>	Top Edge on Top, Top Edge on Left	Select the orientation of the original document top edge to scan correct direction. Choose orientation of the originals, either [Top Edge on Top] or [Top Edge on Left]. Then press the <b>[OK]</b> key.
<b>Book&gt;&gt; 1-sided</b>	<b>Orig. Binding</b>	Left, Right	Select the binding direction of originals, and press the <b>[OK]</b> key.
<b>Book&gt;&gt; 2-sided</b>	<b>Orig. Binding</b>	Left, Right	Select the binding direction of originals, and press the <b>[OK]</b> key.

When placing the original on the platen, consecutively replace each original and press the **[Start]** key.

After scanning all originals, press the **[OK]** key to start copying.

## Combine

Combines 2 or 4 original sheets into 1 printed page. You can select the page layout and the type of boundary lines around the pages.

The following types of the boundary lines are available.

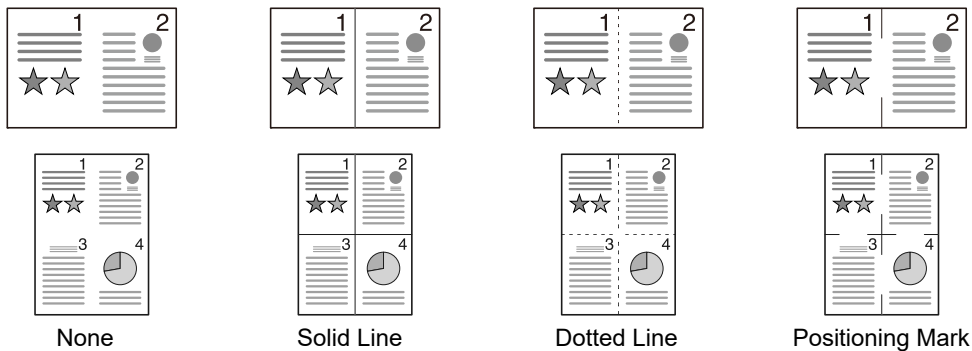

Item		Value	Description
<b>Off</b>		—	Disables the function.
<b>2 in 1</b>		—	Copies the original with the default setting. For the default settings, refer to <a href="#">Function Default on page 7-13</a> .
<b>4 in 1</b>			
<b>Advanced Combine</b>		—	Changes the settings.
<b>2 in 1</b>	<b>Layout</b>	L to R/T to B, R to L	Select the page layout of scanned originals, and press the <b>[OK]</b> key.
	<b>Border Line</b>	None, Solid Line, Dotted Line, Positioning Mark	Select the page boundary line, and press the <b>[OK]</b> key.
	<b>Orig. Orientation</b>	Top Edge on Top, Top Edge on Left	Select the orientation of the original document top edge to scan correct direction. Choose orientation of the originals, either <b>[Top Edge on Top]</b> or <b>[Top Edge on Left]</b> . Then press the <b>[OK]</b> key.
<b>4 in 1</b>	<b>Layout</b>	Right then Down, Down then Right, Left then Down, Down then Left	Select the page layout of scanned originals, and press the <b>[OK]</b> key.
	<b>Border Line</b>	None, Solid Line, Dotted Line, Positioning Mark	Select the page boundary line, and press the <b>[OK]</b> key.
	<b>Orig. Orientation</b>	Top Edge on Top, Top Edge on Left	Select the orientation of the original document top edge to scan correct direction. Choose orientation of the originals, either <b>[Top Edge on Top]</b> or <b>[Top Edge on Left]</b> . Then press the <b>[OK]</b> key.

Layout image

Value		Image
2 in 1	L to R/T to B	
	R to L	
4 in 1	Right then Down	
	Down then Right	
	Left then Down	
	Down then Left	

**NOTE**

- The paper sizes supported in Combine mode are A3, A4-R, A4, A5-R, B4, B5-R, B5, Folio, 216 × 340 mm, Ledger, Letter-R, Letter, Legal, Statement-R, Oficio II, 8K, 16K-R and 16K.
- When placing the original on the platen, be sure to copy the originals in page order.
- If the original size is not set, the screen for setting the original size is displayed. Refer to [Original Size on page 5-20](#).

## Collate/Offset

Offsets the output by page or set.

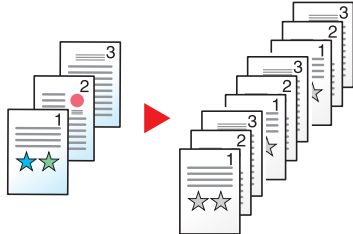
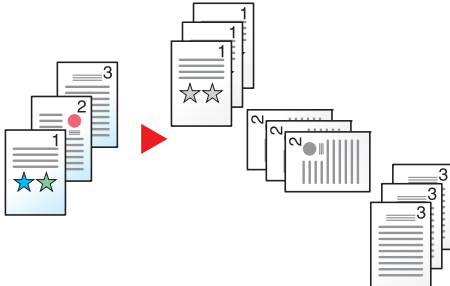
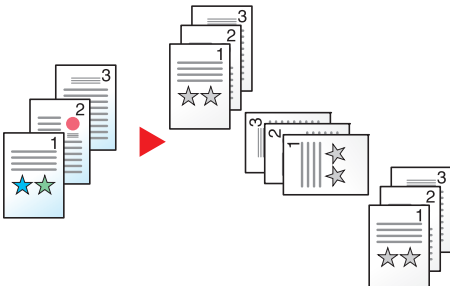
Value	Image	Description
<b>Off</b>	—	Disables the function.
<b>Collate Only</b>		Scans multiple originals and delivers complete sets of copies as required according to page number.
<b>Offset Each Page</b>		When offsetting is used, printed copies are produced after rotating each page by 90 degrees.  <b>NOTE</b> To use offsetting, the same size of paper as the selected paper tray must be loaded in a different orientation in a different paper tray. The paper sizes supported in Offset are A4, B5, Letter and 16K.
<b>Offset Each Set</b>		When offsetting is used, printed copies are produced after rotating each set by 90 degrees.  <b>NOTE</b> To use offsetting, the same size of paper as the selected paper tray must be loaded in a different orientation in a different paper tray. The paper sizes supported in Offset are A4, B5, Letter and 16K.

## Original Size

Specify the original size to be scanned.

Item	Description
<b>Auto</b>	Have the size of original detected automatically.
<b>A3, A4-R, A4, A5-R, A5, A6-R, B4, B5-R, B5, B6-R, B6, Folio, 216 × 340 mm, Ledger, Letter-R, Letter, Legal, Statement-R, Statement, 11 × 15", Oficio II, 8K, 16K-R, 16K, Hagaki, Oufukuhagaki, Custom<sup>*1</sup></b>	Select from standard sizes.

\*1 For instructions on how to specify the custom original sizes, refer to [Custom Orig.Size on page 7-7](#).

### NOTE

Be sure to always specify the original size when using custom size originals.



## Orig. Orientation (Original Orientation)

Select the orientation of the original document top edge to scan correct direction.

To use any of the following functions, the document's original orientation must be set.

- Duplex
- Margin
- Combine

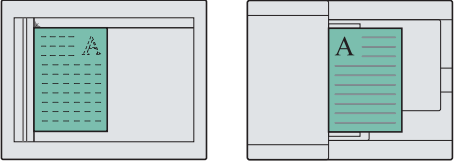
Select original orientation from [Top Edge on Top] or [Top Edge on Left].

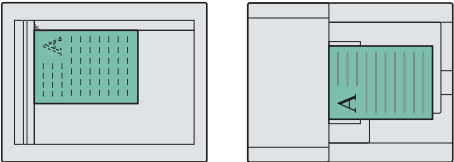
Item	Image	
<p><b>Top Edge on Top</b></p>	 <p>Original</p>	 <p>Original orientation</p>
<p><b>Top Edge on Left</b></p>	 <p>Original</p>	 <p>Original orientation</p>



**NOTE**

The default setting for Original Orientation can be changed. Refer to [Function Default on page 7-13](#) for details.

## Mixed Size Orig. (Mixed Size Originals)

Scans multiple sheets of the same width using the document processor.



 **NOTE**

The optional document processor is required.

Value	Description
Off	Disables the function.
On	Enables Mixed Size Originals.

## EcoPrint

EcoPrint saves toner when printing. Use this function for test prints or any other occasion when high quality print is not required.

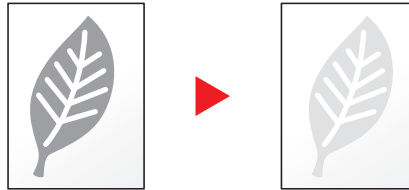

Value	Description
Off	Disables the function.
On	Enables EcoPrint.

## Backgrnd Density (Background Density)

Removes dark background from originals, such as newspapers.

Value	Description
Off	Disables the function.
On	Enables Background Density.

## Margin

Add margins (white space). In addition, you can set the margin width and the back page margin.

 **NOTE**

The default setting for margin width can be changed. For details, refer to [Margin on page 7-13](#).

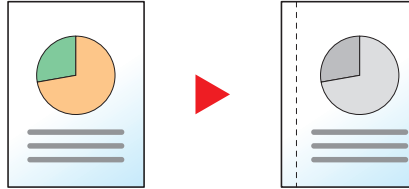

Item	Value	Description
<b>Off</b>	—	Disables the function.
<b>On</b>	—	Copies the original with the default setting. For the default settings, refer to <a href="#">Function Default on page 7-13</a> .
<b>Advanced Margin</b>	—	Changes the settings.
<b>Left/Right</b>	Metric: -18 mm to +18 mm (in 1 mm increments) Inch: -0.75 to +0.75" (in 0.01" increments)	Set the margin width.* <sup>1</sup> Use the numeric keys or press the [▲] or [▼] key to enter the margins for [Left/Right], and press the [OK] key.
<b>Top/Bottom</b>	Metric: -18 mm to +18 mm (in 1 mm increments) Inch: -0.75 to +0.75" (in 0.01" increments)	Set the margin width.* <sup>1</sup> Use the numeric keys or press the [▲] or [▼] key to enter the margins for [Top/Bottom], and press the [OK] key.
<b>Orig. Orientation</b>	Top Edge on Top, Top Edge on Left	Select the orientation of the original document top edge to scan correct direction. Choose orientation of the originals, either [Top Edge on Top] or [Top Edge on Left]. Then press the [OK] key.
<b>Back Page Margin</b> * <sup>2</sup>	Auto, Manual	For duplex copying, select [Auto] or [Manual]. When [Auto] is selected, an appropriate margin is applied automatically on the rear page depending on a margin specified for the front page and a binding orientation. When [Manual] is set, you can set a different margin than the front on the back. Set the margin in the screen that is displayed. The setting selections are the same as for the front.

\*1 The input units can be changed in System Menu. For details, refer to [Measurement on page 7-11](#).

\*2 The optional duplex unit is required.

## Border Erase

Erases the black border that forms around the image. The following modes are available.

### Border Erase Sheet

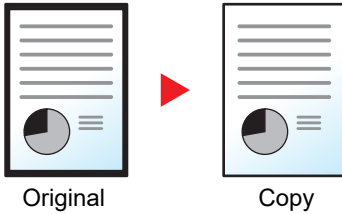

Erases black borders around the single sheet original.

### Border Erase Book

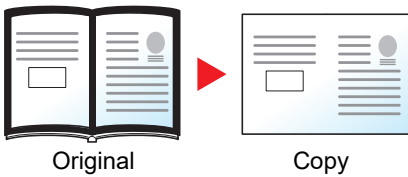

Erases black borders around the edges and in the middle of the original such as a thick book. You can specify the widths individually to erase the borders around the edges and in the center of the book.

#### NOTE

The default setting for border erase width can be changed. For details, refer to [Border Erase on page 7-13](#).

Item		Value	Description
<b>Off</b>		—	Disables the function.
<b>Sheet</b>		—	Copies the original with the default setting. For the default settings, refer to <a href="#">Function Default on page 7-13</a> .
<b>Book</b>			
<b>Advanced Erase</b>		—	Changes the settings.
<b>Sheet</b>	<b>Border</b>	Metric: 0 mm to 50 mm (in 1 mm increments) Inch: 0.00 to 2.00" (in 0.01" increments)	Set the border erase width. <sup>*1</sup> Use the numeric keys or press the [▲] or [▼] key to enter the border erase width, and press the [OK] key.
	<b>Back Page<sup>*2</sup></b>	Same as FrontPage, Do Not Erase	For 2-sided originals, select [Same as FrontPage] or [Do Not Erase], and press the [OK] key.
<b>Book</b>	<b>Border</b>	Metric: 0 mm to 50 mm (in 1 mm increments) Inch: 0.00 to 2.00" (in 0.01" increments)	Set the border erase width. <sup>*1</sup> Use the numeric keys or press the [▲] or [▼] key to enter the border erase width, and press the [OK] key.
	<b>Gutter</b>		
	<b>Back Page<sup>*2</sup></b>	Same as FrontPage, Do Not Erase	For 2-sided originals, select [Same as FrontPage] or [Do Not Erase], and press the [OK] key.

\*1 The input units can be changed in System Menu. For details, refer to [Measurement on page 7-11](#).

\*2 The optional duplex unit is required.



## Continuous Scan

Scans a large number of originals in separate batches and then produce as one job.  
 To scan the next original, press the **[Start]** key.  
 After scanning all originals, press the **[OK]** key. Copying starts.

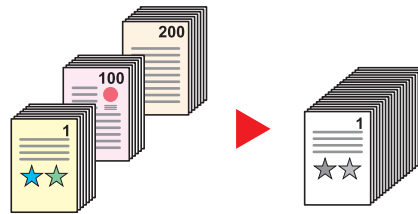

Value	Description
Off	Disables the function.
On	Enables Continuous Scan.

## Auto Rotation

Automatically rotates the image 90 degrees when the sizes of the original and the loaded paper matches but the orientations are different.

Value	Description
Off	Disables the function.
On	Enables Auto Rotation.



### NOTE

You can select whether to rotate the image automatically in the default settings. For details, refer to [Auto Rotation on page 7-13](#).

## File Name Entry

Adds a file name. Additional information such as job number can also be set. You can check a job history or job status using the file name or job number specified here.

Enter the file name (up to 32 characters), and press the **[OK]** key.

To specify a job number, select **[Additional Info.]** and press the **[OK]** key.



[Character Entry Method \(page 10-4\)](#)

# Program

By registering sets of frequently used functions as a single program, you can simply select the program number as needed to recall those functions. You can also name the programs for easy identification when recalling.

**NOTE**

- Only copying functions can be registered and recalled as programs.
- Up to 4 programs can be registered.

## Registering Program

Use the procedure below to register a program.

### 1 Configure the settings of the functions.

Configure the settings of the functions you want to register in a program.

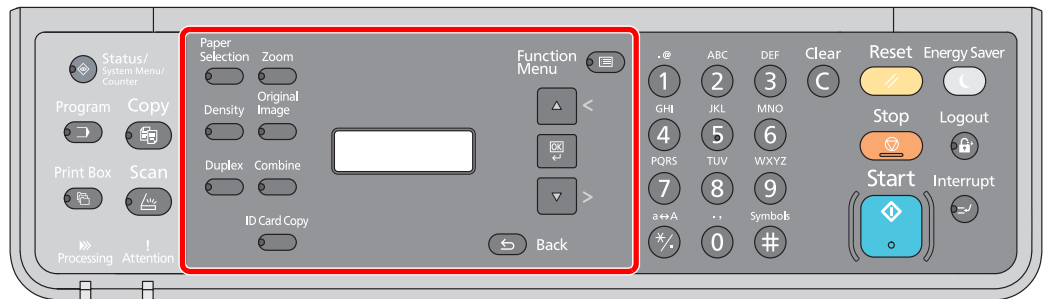

For the settings of functions, refer to [Using Various Functions on page 5-11](#).

### 2 Register the program.

- 1 Press the [Program] key.

Program



- 2 Press the [▲] or [▼] key to select a program number (01 to 04) to register, and press the [OK] key.

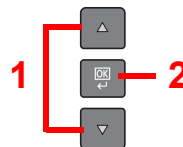
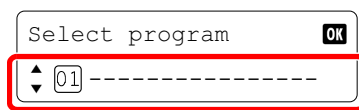

**NOTE**

- Unregistered program numbers are displayed with [-----].
- If you select a program number already registered, the currently registered functions can be replaced with a new set of functions.

- 3 Press the [▲] or [▼] key to select [Add], and press the [OK] key.

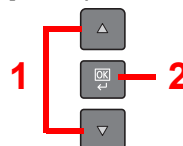
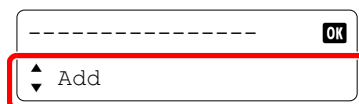

- 4 Enter a program name using the numeric keys and press the [OK] key.

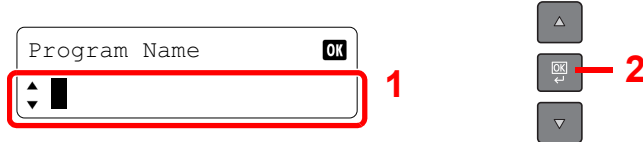

The program is registered.

 [Character Entry Method \(page 10-4\)](#)

 **NOTE**

- Up to 32 characters can be entered.
- If the program number is already used in any of the existing programs, the change confirmation screen appears. Press the [▲] or [▼] key to select [Yes] or [No], and press the [OK] key.
- The settings can be confirmed by recalling the program. Refer to [Recalling Program on page 5-27](#).

## Confirming the Registered Program

The settings of the registered program can be confirmed by recalling the program. Refer to [Recalling Program on page 5-27](#).

## Recalling Program

Use the procedure below to recall a registered program.

### 1 Recall the program.

- 1 Press the [Program] key.

Program



- 2 Press the [▲] or [▼] key to select a program number (01 to 04) to recall, and press the [OK] key.

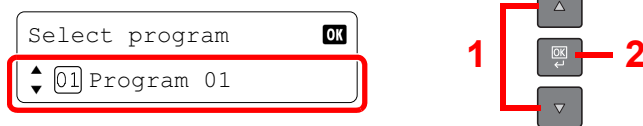

- 3 Press the [▲] or [▼] key to select [Recall], and press the [OK] key.



### 2 Execute the program.

Place the originals and press the [Start] key.

## Overwriting Program

Programs can be changed with the same procedures as those for registering programs. When selecting the program number to be registered, select the program to be changed and overwrite the program number. Refer to [Registering Program on page 5-26](#).

## Changing the Program Name

Use the procedure below to change the program name.

### 1 Display the screen.

- 1 Press the [Program] key.

Program



- 2 Press the [▲] or [▼] key to select a program number (01 to 04) to edit, and press the [OK] key.

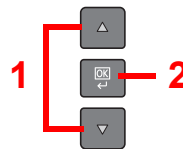
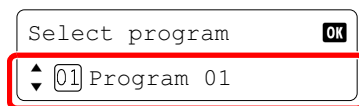

### 2 Edit the program name.

- 1 Press the [▲] or [▼] key to select [Edit Name], and press the [OK] key.

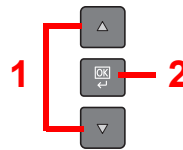
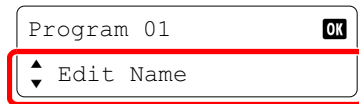

- 2 Enter a program name using the numeric keys and press the [OK] key.



- 3 Press the [▲] or [▼] key to select [Yes] in the confirmation screen, and press the [OK] key.

## Deleting Program

Use the procedure below to delete a program.

### 1 Display the screen.

- 1 Press the [Program] key.

Program



- 2 Press the [▲] or [▼] key to select a program number to delete, and press the [OK] key.

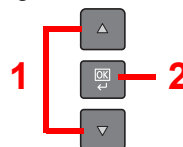
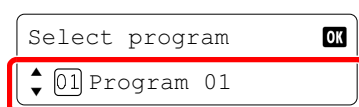

## 2 Delete the program.

- 1 Press the [▲] or [▼] key to select [Delete], and press the [OK] key.



- 2 Press the [▲] or [▼] key to select [Yes] in the confirmation screen, and press the [OK] key.

## Canceling Jobs

You can cancel jobs by pressing the **[Stop]** key.

Stop



### When a job is being executed

The copy job is canceled.

### When there are waiting jobs

[Print Job List] is displayed.

- 1 Press the **[▲]** or **[▼]** key to select the job to cancel, and press the **[OK]** key.



#### NOTE

Two jobs are displayed in the order of reception by the machine.

- 2 Press the **[▲]** or **[▼]** key to select [Cancel Job], and press the **[OK]** key.

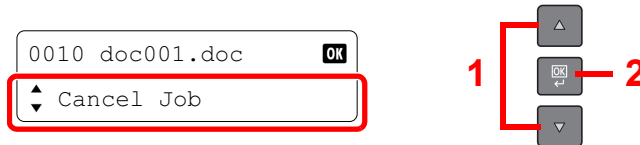

#### NOTE

Select [Details] and press the **[OK]** key to show the detailed information of the job.

- 3 Press the **[▲]** or **[▼]** key to select [Yes] in the confirmation screen, and press the **[OK]** key.



The job is canceled.

# Scanning

You can scan originals using the machine and save the scanned images on your computer. The following three types of scan are available.

## Scan the Image to the Specified Destination

### Use the Preset Scan Destination

If originals are scanned after selecting [Local PC] as the destination, an image is saved in "My Documents" in the computer (Host PC) connected to the machine via USB. If KYOCERA Client Tool is activated on the Host PC, originals can be scanned only by operating the machine.

- 1 Scan the originals at the machine. (Refer to [Scan the Image to the Specified Destination on page 5-33.](#))
- 2 An image is saved in "My Documents."

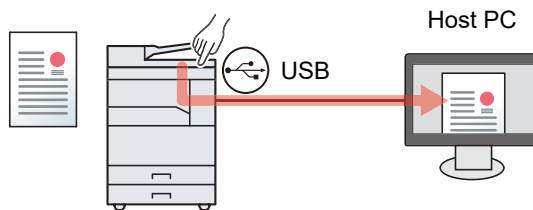

### Use Your Desired Destination

When saving an image in a location other than "My Documents", the destination needs to be set beforehand by using KYOCERA Client Tool. If the shared folder in the computer (Client PC) on the network is selected for the destination, an image can be saved on the computer that is not connected to the machine via USB.

- 1 Preset the destination by using KYOCERA Client Tool. (Refer to [Default Settings on the PC \(KYOCERA Client Tool\) on page 7-16.](#))
- 2 Scan the originals at the machine. (Refer to [Use Your Desired Destination on page 5-34.](#))
- 3 An image is saved in the folder set by KYOCERA Client Tool.

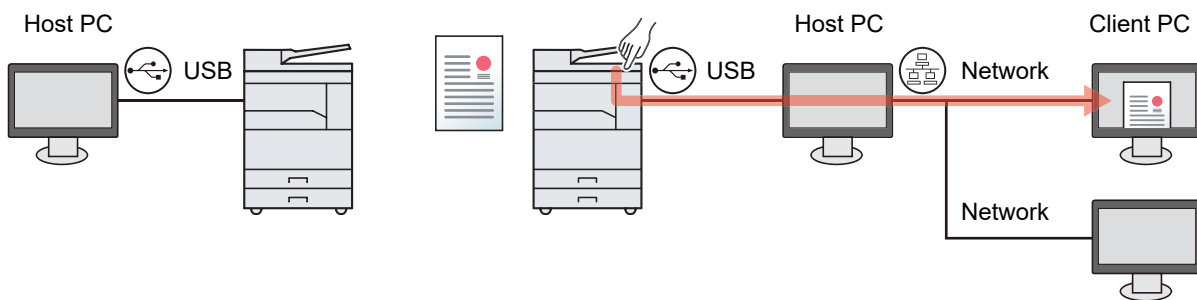

## Scan the Image by Selecting the Destination (Quick Scan)

Select the scan method and destination for each job by using KYOCERA Client Tool.

Perform a scan by operating the computer (Host PC) connected to the machine via USB. If the shared folder in the computer (Client PC) on the network is selected for the destination, an image can be saved on the computer that is not connected to the machine via USB.

**1** Perform a scan by using KYOCERA Client Tool. (Refer to [Scan the Image by Selecting the Destination \(Quick Scan\) on page 5-35](#))

**2** An image is saved in the folder set by KYOCERA Client Tool.

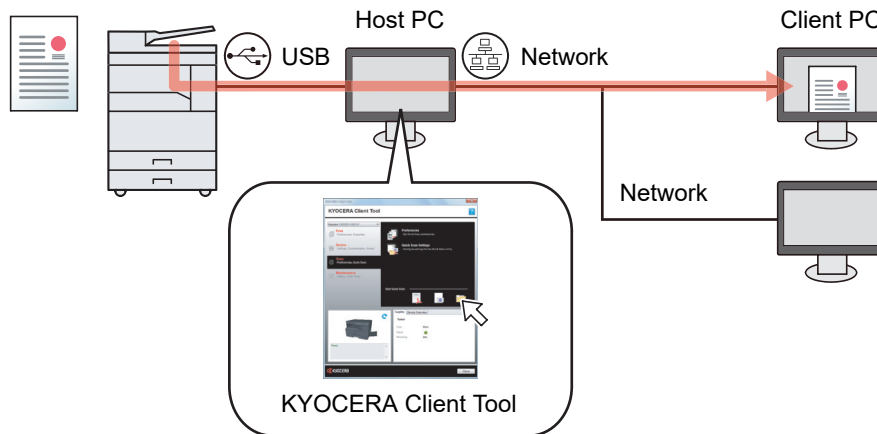

With Quick Scan, the following 3 types of scan are possible.

- Scan to PDF: Saves the scanned image in PDF format.
- Scan to Email: Attaches the scanned image to a new E-mail message.
- Scan to Folder: Saves the scanned image to a specified folder.

## Scanning using TWAIN

Make the image processing application read the scanned image. This function is available only for the computer connected via USB. (Refer to [Scanning using TWAIN on page 5-36.](#))



## Scan the Image to the Specified Destination

It is easy to scan from the operation panel on the machine. Before using this function, you need to preset the destination folder where to save scanned image and image quality using KYOCERA Client Tool. Refer to [Default Settings on the PC \(KYOCERA Client Tool\) on page 7-16](#).

### Use the Preset Scan Destination

Save the scanned image in the preset scan destination. My Documents is set for the destination. Scanning can be performed without preparing the destination.

#### 1 Start KYOCERA Client Tool on the Host PC.

Refer to [Accessing KYOCERA Client Tool on page 2-19](#).

#### 2 Press the [Scan] key on the machine.

Scan



#### 3 Place the originals.

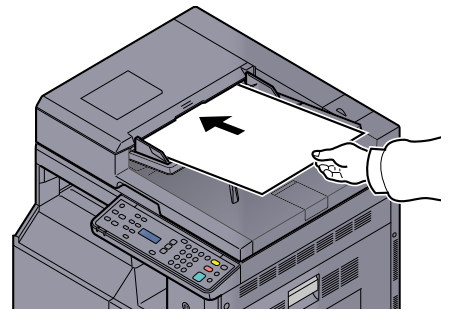
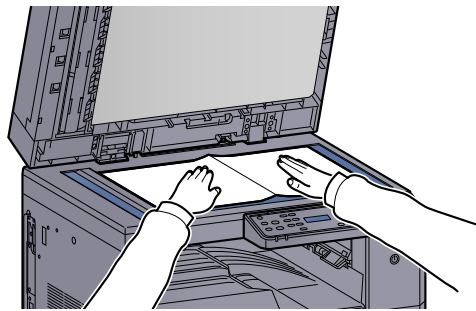

 [Loading Originals \(page 5-2\)](#)

#### 4 Press the [Start] key.

Start



Scanning starts.



#### NOTE

Ready to scan.

▲ [01] Local PC

- If [Local PC] is selected as the destination, an image is saved in "My Documents" in the computer (Host PC) connected to the machine via USB.  
Windows Vista/Windows 7/Windows 8: C:\Users\\My Documents  
Windows XP: C:\Document and Settings\\My Documents
- When the scan ends, the folder in which an image is saved opens on the Host PC.

## Use Your Desired Destination

If there are settings that you change from "My Documents" in the computer (Host PC) connected to the machine via USB, set the destination by using KYOCERA Client Tool. You can simply select the destination number as needed to recall those functions.

Ten destinations including the default [Local PC] can be registered. Refer to [Default Settings on the PC \(KYOCERA Client Tool\) on page 7-16](#).

### 1 Start KYOCERA Client Tool on the Host PC.

Refer to [Accessing KYOCERA Client Tool on page 2-19](#).

### 2 Press the [Scan] key on the machine.

Scan



### 3 Place the originals.

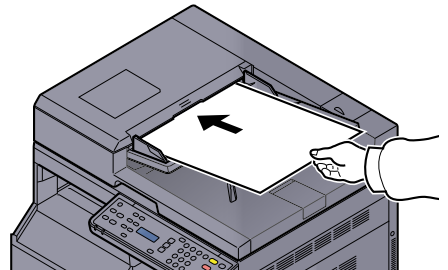
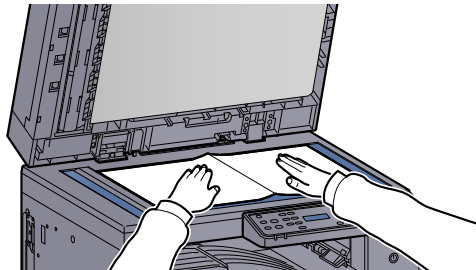

 [Loading Originals \(page 5-2\)](#)

### 4 Select the destination number.

Press the [▲] or [▼] key to select a destination number (01 to 10) to recall, and press the [OK] key.

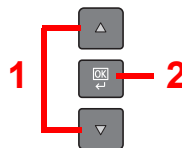
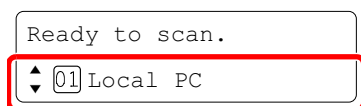

#### NOTE

The name set by using KYOCERA Client Tool appears. [-----] appears for the destination for which no name is set.

### 5 Press the [Start] key.

Start



Scanning starts.

When the scan ends, the folder in which an image is saved opens on the Host PC.

## Scan the Image by Selecting the Destination (Quick Scan)

Execute scanning from KYOCERA Client Tool.

You need to configure the settings of Quick Scan and TWAIN using KYOCERA Client Tool. Refer to [Default Settings on the PC \(KYOCERA Client Tool\) on page 7-16](#).

KYOCERA Client Tool needs to be operated on the computer (Host PC) connected to the machine via USB.

### 1 Place the originals on the machine.

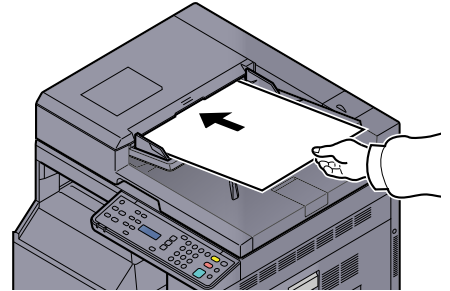
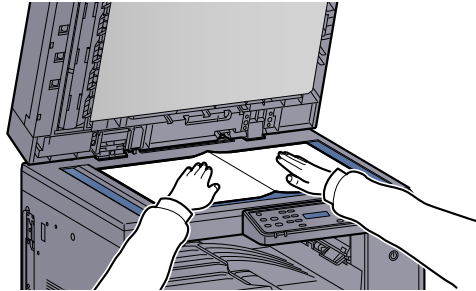



 [Loading Originals \(page 5-2\)](#)

### 2 Execute scanning on the Host PC.

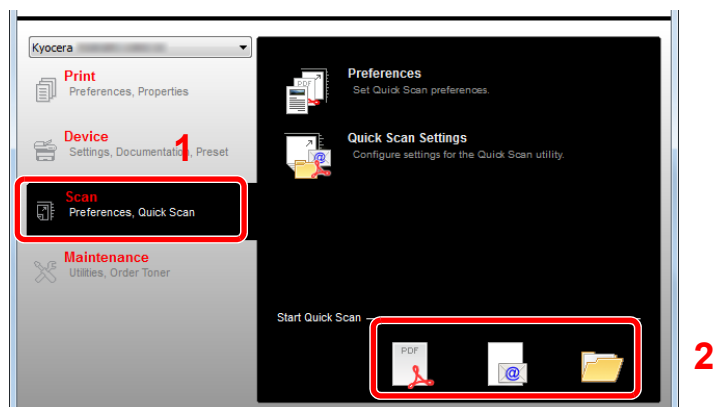
- 1 Start KYOCERA Client Tool as explained in [Accessing KYOCERA Client Tool on page 2-19](#).
- 2 Click [**Scan to PDF**], [**Scan to Email**] or [**Scan to Folder**] icon on the [**Scan**] tab.



- Scan to PDF  Scanning starts. When scanning finishes, the [**Save PDF File As**] dialog appears. Specify the PDF file name and the folder in which the image will be saved.
- Scan to Email  Scanning starts. When scanning finishes, the mailer starts and the scanned image is attached. Enter the address, subject and message, and then send.
- Scan to Folder  The [**Browse for Folder**] dialog appears. Specify the folder in which the image will be saved, and click [**OK**]. Scanning starts.

## Scanning using TWAIN

This section explains how to scan an original using TWAIN.

The procedure for scanning using the TWAIN driver is explained as an example. The WIA driver is used in the same way.

### 1 Place the originals.

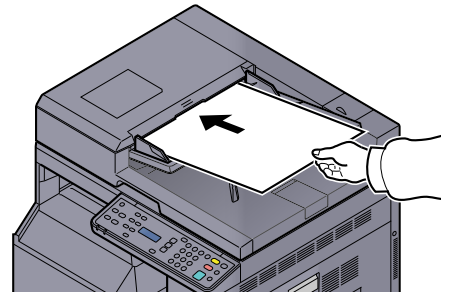
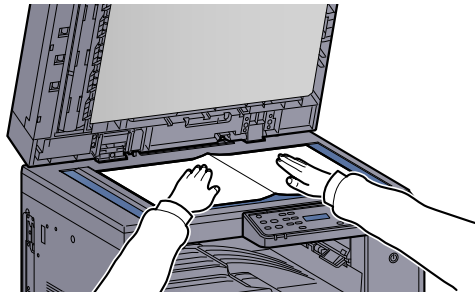

 [Loading Originals \(page 5-2\)](#)

### 2 Display the screen.

- 1 Activate the TWAIN compatible application software.
- 2 Select the machine using the application and display the [TWAIN] dialog box.

#### NOTE

For selecting the machine, see the Operation Guide or Help for each application software.

### 3 Configure the scan settings.

Select scanning settings in the TWAIN dialog box that opens.

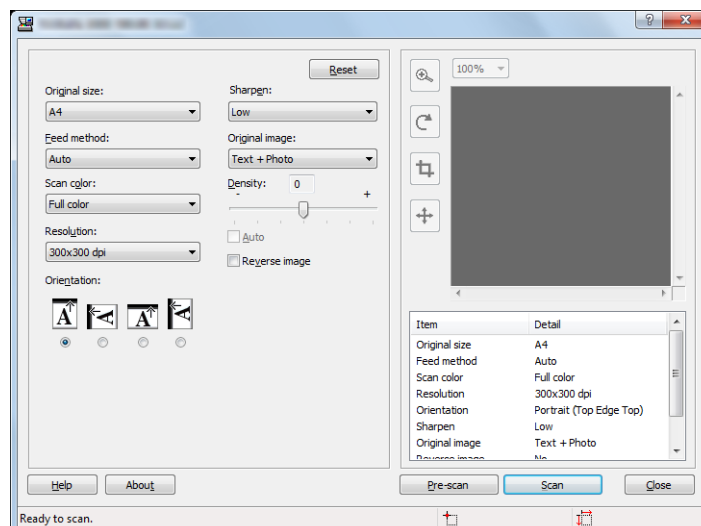

Configure the scan settings as needed. For details, refer to Help.

### 4 Scan the originals.

Click the [Scan] button. The document data is scanned.

## Canceling Jobs

You can cancel jobs by pressing the **[Stop]** key.

Stop



# 6 Checking the Status

This chapter explains the following topics:

Checking Job Status .....	6-2
Checking Job History .....	6-4
Pause and Resumption of Jobs .....	6-7
Canceling the Jobs in Printing/Waiting .....	6-8
Checking Device Status .....	6-9
Checking the Remaining Amount of Toner and Paper .....	6-10
Checking from KYOCERA Client Tool .....	6-11

# Checking Job Status

Check the status of jobs being processed or waiting to be printed.

## Available Status Screens

You can check the status of jobs being processed or waiting on the message display. The following job statuses are available.

Status Display	Job status to be displayed
Print Job Status	<ul style="list-style-type: none"> <li>• Copy</li> <li>• Printer</li> <li>• Printing from Print Box</li> <li>• Job Report/List</li> </ul>

## Displaying Status Screens

### 1 Display the screen.

- 1 Press the [Status/System Menu/Counter] key.



- 2 Press the [▲] or [▼] key to select [Status], and press the [OK] key.

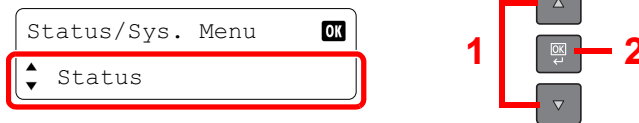

- 3 Press the [▲] or [▼] key to select [Print Job Status], and press the [OK] key.

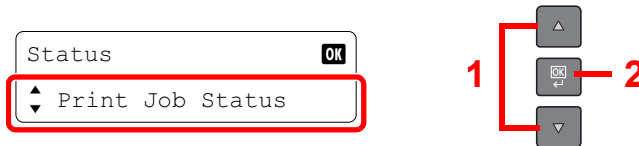

### 2 Select the job you want to check.

- 1 Press the [▲] or [▼] key to select the job you want to check, and press the [OK] key.

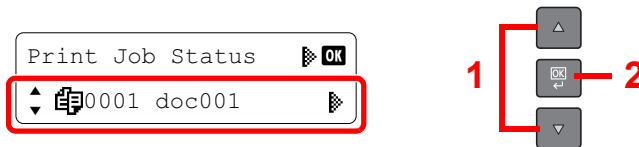

- 2 Press the [▲] or [▼] key to select [Detail], and press the [OK] key.

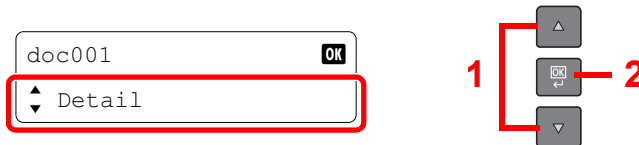

### 3 Check the status.

Press the [▲] or [▼] key to select the item you want to check. Then, press the [OK] key to show the information on the item.

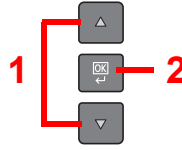

To check other items, press the [Back] key to return to the previous screen.

Item	Description
<b>Status</b>	Status of job [Processing]: The status before starting to print. [Pause]: Pausing print job or error [Canceling]: Canceling the job
<b>Job Name</b>	—
<b>Job Type</b>	[Copy]: Copy job [Printer]: Printer job [Report]: Report/List
<b>Page and Copy</b>	<ul style="list-style-type: none"> <li>• Number of pages printed</li> <li>• Number of copies printed / Total number of copies to be printed</li> </ul> (Press the [▲] or [▼] key to switch the screens.)
<b>Original Pages</b>	Number of original pages



# Checking Job History

Check the history of completed jobs.

## Available Job History Screens

The following job histories are available.

Screen	Job histories to be displayed
Print Job Log	<ul style="list-style-type: none"> <li>• Copy</li> <li>• Printer</li> <li>• Printing from Print Box</li> <li>• Job Report/List</li> </ul>
Send Job Log	<ul style="list-style-type: none"> <li>• Scan (only for TWAIN)</li> </ul>

## Displaying Job History Screen

### 1 Display the screen.

- 1 Press the [Status/System Menu/Counter] key.



- 2 Press the [▲] or [▼] key to select [Status], and press the [OK] key.

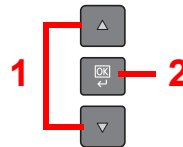
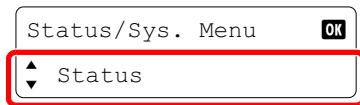

- 3 Press the [▲] or [▼] key to select [Print Job Log] or [Send Job Log], and press the [OK] key.

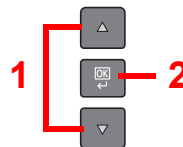
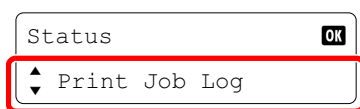

### 2 Select the job you want to check.

Press the [▲] or [▼] key to select the job you want to check, and press the [OK] key.

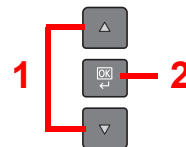
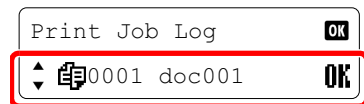

### 3 Check the job history.

Press the [**▲**] or [**▼**] key to select the item you want to check. Then, press the [**OK**] key to show the information on the item.

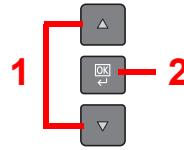
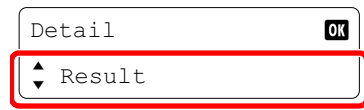

To check other items, press the [**Back**] key to return to the previous screen.

### Print Job Log

Item	Description
<b>Result</b>	Result of job [OK]: The job has been completed. [Error]: An error has occurred. [Cancel]: The job has been canceled.
<b>Job Name</b>	—
<b>Job Type</b>	[Copy]: Copy job [Printer]: Printer job [Report]: Report/List
<b>Page and Copy</b>	<ul style="list-style-type: none"> <li>Number of pages printed</li> <li>Number of copies printed / Total number of copies to be printed</li> </ul> (Press the [ <b>▲</b> ] or [ <b>▼</b> ] key to switch the screens.)
<b>Original Pages</b>	Number of original pages

### Send Job Log

Item	Description
<b>Result</b>	Result of job [OK]: The job has been completed. [Error]: An error has occurred. [Cancel]: The job has been canceled.
<b>Job Name</b>	—
<b>Job Type</b>	[Application] is displayed.
<b>Original Pages</b>	Number of original pages
<b>Color/B &amp; W</b>	Color mode of scan data [Full Color] [Black & White] [Grayscale]
<b>Destination</b>	[-----] is displayed.



**NOTE**

If the login user name entry screen appears during operations, log in by referring to [Administrator User Name and Password on page 2-21](#).

The factory default login user name and login password are set as shown below.

Login User Name	Login Password
Admin *1	Admin *1

\*1 Upper case and lower case letters are distinguished (case sensitive).

# Pause and Resumption of Jobs

Pause/resume all printing jobs in printing/waiting.

## 1 Display the screen.

- 1 Press the [**Status/System Menu/Counter**] key.



- 2 Press the [**▲**] or [**▼**] key to select [Status], and press the [**OK**] key.

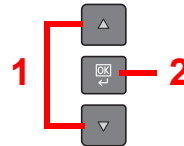
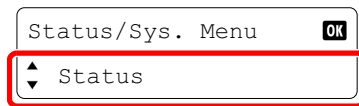

- 3 Press the [**▲**] or [**▼**] key to select [Print Job Status], and press the [**OK**] key.

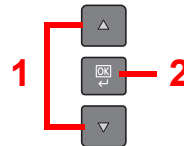
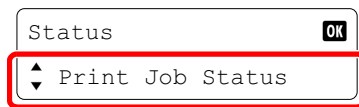

## 2 Select [Pause print jobs].

Press the [**▲**] or [**▼**] key to select [Pause print jobs], and press the [**OK**] key. Printing is paused.

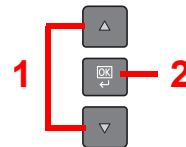
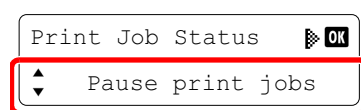

When resuming the printing of jobs that have been paused, press the [**▲**] or [**▼**] key to select [Resume print jobs], and press the [**OK**] key.



### NOTE

If the [**Back**] key or other function key, such as the [**Copy**] key, is pressed during Pause, [Resume paused job] appears. If [Yes] is selected and then the [**OK**] key is pressed, the job is resumed and the following screen appears. If [No] is selected and then the [**OK**] key is pressed, the following screen appears while the job is paused.

# Canceling the Jobs in Printing/Waiting

Cancel the printing jobs in printing/waiting.

## 1 Display the screen.

- 1 Press the [Status/System Menu/Counter] key.



- 2 Press the [▲] or [▼] key to select [Status], and press the [OK] key.

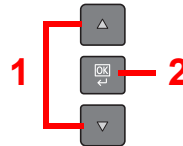
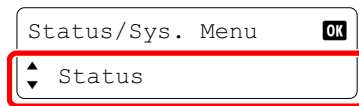

- 3 Press the [▲] or [▼] key to select [Print Job Status], and press the [OK] key.

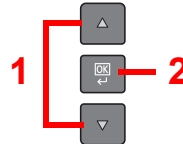
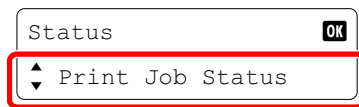

## 2 Cancel a job.

- 1 Press the [▲] or [▼] key to select the job to be canceled, and press the [OK] key.

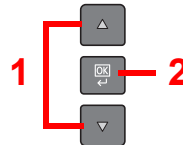
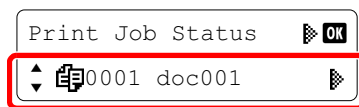

### NOTE

Two jobs are displayed in the order of reception by the machine.

- 2 Press the [▲] or [▼] key to select [Cancel Job], and press the [OK] key.

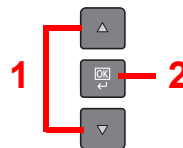
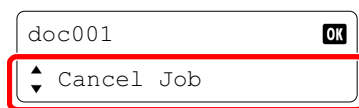

- 3 Press the [▲] or [▼] key to select [Yes] in confirmation screen, and press the [OK] key.

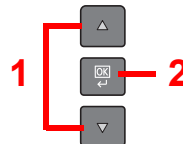
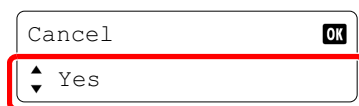

# Checking Device Status

Configure the devices or check their status.

## 1 Display the screen.

- 1 Press the [Status/System Menu/Counter] key.



- 2 Press the [▲] or [▼] key to select [Status], and press the [OK] key.

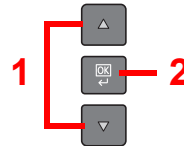
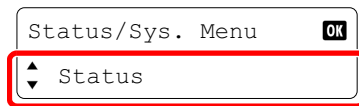

## 2 Check the status.

Press the [▲] or [▼] key to select [Scanner] or [Printer]. Then, press the [OK] key to show the status of the selected device.

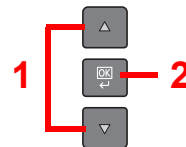
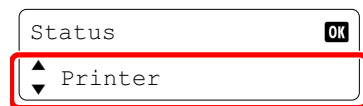

### Scanner

Item	Description
Ready.	The device is ready.
Pausing...	The device is being paused.
Scanning...	The device is scanning.
Please wait.	The device is initializing.

### Printer

Item	Description
Ready.	The device is ready.
Pausing...	The device is being paused.
Printing...	The device is printing.
Please wait.	The device is initializing.
Processing...	The device is processing print job.

# Checking the Remaining Amount of Toner and Paper

Check the remaining amount of toner and paper on the message display.

## 1 Display the screen.

- 1 Press the [Status/System Menu/Counter] key.



- 2 Press the [▲] or [▼] key to select [Status], and press the [OK] key.

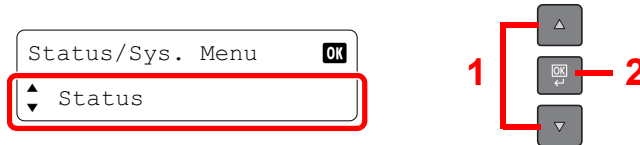

## 2 Check the status.

Press the [▲] or [▼] key to select [Toner Status] or [Paper Status], and press the [OK] key

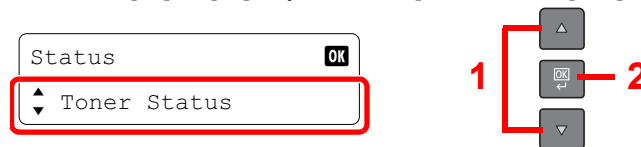

### Toner Status

You can check the remaining amount of toner level from 100 to 0% (10% increments).

### Paper Status

Press the [▲] or [▼] key to select a paper source from [Cassette 1 (to 4)] or [MP Tray]. Then, press the [OK] key to show the status of the selected source.

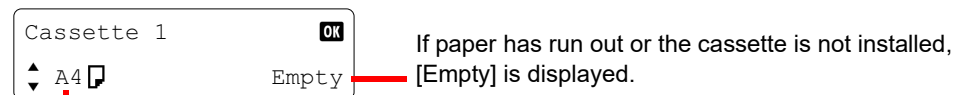

The paper size and media type specified for the selected source are displayed. (Press the [▲] or [▼] key to switch the screens.)





### NOTE

- If the paper size is unclear, [----] appears.
- [Cassette 2 (to 4)] are displayed when the optional paper feeder is installed.

# Checking from KYOCERA Client Tool

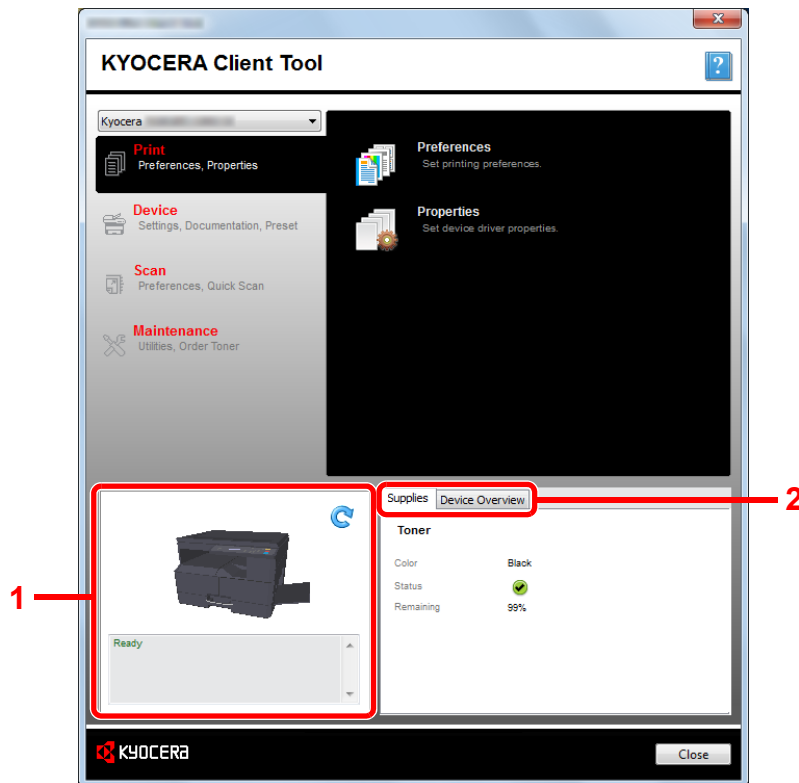
You can check the current status of the machine from the KYOCERA Client Tool.



No.	Item	Description
1	Machine status	Show a 3D image of the selected machine and its current status. Click  (Refresh) to refresh the machine status.
2	Supplies	Show the toner status.
	Device Overview	Show the machine settings.



# 7 System Menu and KYOCERA Client Tool

This chapter explains the following topics:

Default Settings on the Machine (System Menu) .....	7-2
System Menu Settings .....	7-3
Report .....	7-4
System .....	7-5
Admin/Accounting .....	7-5
Common Settings .....	7-5
Copy .....	7-14
Printer .....	7-15
Adjust/Maint. (Adjustment/Maintenance) .....	7-15
Default Settings on the PC (KYOCERA Client Tool) .....	7-16
Operation Method .....	7-16
Screen Overview .....	7-17
Configuring the Administrative Settings .....	7-19
Scan Destination Settings .....	7-20
Quick Scan/TWAIN Settings .....	7-23
Print Box Settings .....	7-26

# Default Settings on the Machine (System Menu)

Configure settings related to overall machine operation.

Press the [[Status/System Menu/Counter](#)] key to show the settings on the message display. Then, select from the settings displayed.

 [Operation Method \(page 3-3\)](#).

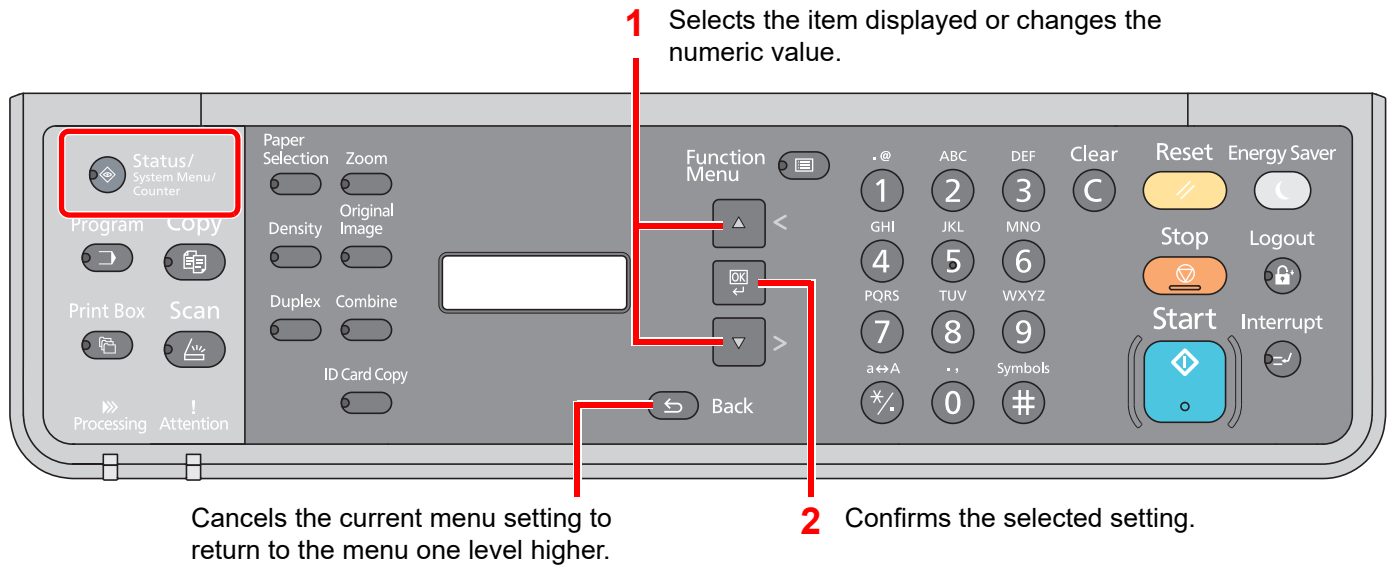

## NOTE

- If the login user name entry screen appears during operations, log in by referring to [Administrator User Name and Password on page 2-21](#).

The factory default login user name and login password are set as shown below.

Login User Name	Login Password
Admin*1	Admin*1

\*1 Upper case and lower case letters are distinguished (case sensitive).

- If settings are changed, the changes are immediately reflected when the [[Reset](#)] key is pressed.

Refer to [System Menu Settings](#) on the following page and configure as needed.

## System Menu Settings

This section explains the functions that can be configured in System Menu. To configure the settings, select the item in System Menu and press the setting item. For details on each function, see the table below.

Item	Description	Reference Page
<b>Status</b>	Check job statuses and histories, machine statuses, and the remaining amount of paper and toner. Pausing or canceling of jobs can also be executed.	<a href="#">page 6-1</a>
<b>Report</b>	Print reports to check the machine settings, status, and history.	<a href="#">page 7-4</a>
<b>Report Print</b>	Print reports.	<a href="#">page 7-4</a>
<b>Counter</b>	Check the number of sheets printed and scanned.	<a href="#">page 2-27</a>
<b>System</b>	Configure machine system settings.	<a href="#">page 7-5</a>
<b>I/F Block Set.</b>	Protect the machine by blocking the USB interface.	<a href="#">page 7-5</a>
<b>Admin/Accounting</b>	Configure settings related to machine management. For details on Administrator Setting, refer to <a href="#">Administrator Setting on page 2-21</a> , and for details on job accounting, refer to <a href="#">Enabling Job Accounting on page 8-3</a> .	—
<b>Common Settings</b>	Configure overall machine operation.	<a href="#">page 7-5</a>
<b>Language</b>	Select the language displayed on the message display.	<a href="#">page 7-5</a>
<b>Default Screen</b>	Select the screen appearing right after start-up (default screen).	<a href="#">page 7-6</a>
<b>Sound</b>	Set options for buzzer sound during the machine operations.	<a href="#">page 7-6</a>
<b>Display Bright.</b>	Set the brightness of the message display.	<a href="#">page 7-6</a>
<b>Quiet Mode</b>	Make after-printing process run more quietly. Select this mode when the running noise is uncomfortable.	<a href="#">page 7-6</a>
<b>Orig./Paper Set.</b>	Configure settings for originals and paper.	<a href="#">page 7-7</a>
<b>Preset Limit</b>	Restrict the number of copies that can be made at one time.	<a href="#">page 7-11</a>
<b>Measurement</b>	Select inch or metric for the unit for paper dimensions.	<a href="#">page 7-11</a>
<b>Error Handling</b>	Select whether to cancel or continue the job when error has occurred.	<a href="#">page 7-11</a>
<b>Timer Settings</b>	Configure settings related to the time.	<a href="#">page 7-12</a>
<b>Function Default</b>	Defaults are the values automatically set after the warm-up is completed or the [Reset] key is pressed. Set the defaults for available settings. Setting the frequently-used values as defaults makes subsequent jobs easier.	<a href="#">page 7-13</a>
<b>Copy</b>	Configure settings for copying functions.	<a href="#">page 7-14</a>
<b>Printer</b>	When printing from computers, settings are generally made on the application software screen. However, the following settings are available for configuring the defaults to customize the machine.	<a href="#">page 7-15</a>
<b>Adjust/Maint.</b>	Adjust printing quality and conduct machine maintenance.	<a href="#">page 7-15</a>

# Report

Print reports to check the machine settings and status.

## Report Print

Status/  
System Menu/  
Counter
▶ Report
▶ Report Print

If the system menu is operated without a login (account ID is not entered) while job accounting is enabled, the account ID must be entered before the report can be printed.

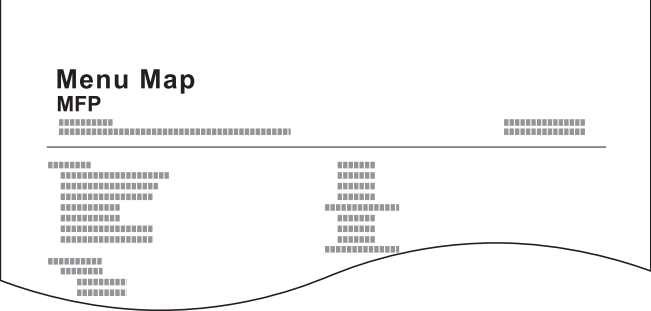
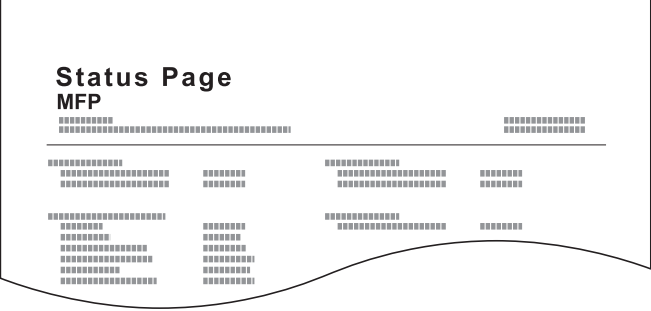
Item		Description
Report Print	Menu Map	Prints Menu Map to check the settings of the machine.  
	Status Page	Prints the status page, allowing you to check the information including current settings, available memory space, and optional equipment installed.  
	Service Status	Prints the service status. More detailed information is available than on the Status Page. Service personnel usually print the service status pages for maintenance purpose.

## System

Configure machine system settings.

### I/F Block Set. (Interface Block Setting)

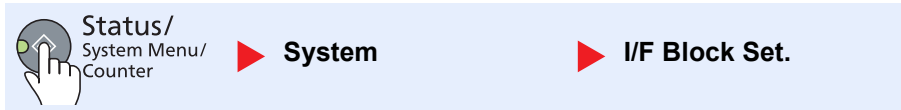

Protect the machine by blocking the USB interface.

Item		Description
I/F Block Set.	USB Device	This locks and protects the USB interface connector (USB Device). <b>Value: Unblock, Block</b>

#### ✔ IMPORTANT

After changing the setting, turn the machine OFF and then ON.

## Admin/Accounting

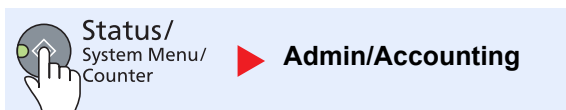

Configure settings related to machine management.

-  [Administrator Setting \(page 2-21\)](#)
- [Job Accounting \(page 8-1\)](#)
- [Unknown ID Job \(page 8-11\)](#)

## Common Settings

Configure overall machine operation.

### Language

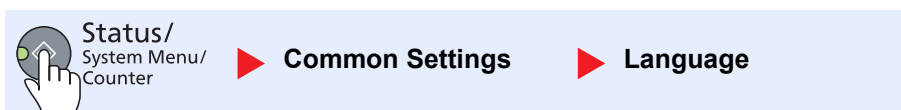

Item	Description
Language	Select the language displayed on the message display.

## Default Screen

 Status/  
System Menu/  
Counter
 ▶ Common Settings
▶ Default Screen

Item	Description
<b>Default Screen</b>	Select the screen appearing right after start-up (default screen). <b>Value:</b> Copy, Scan, Print Box, Program

## Sound

 Status/  
System Menu/  
Counter
 ▶ Common Settings
▶ Sound

Item	Description
<b>Sound</b>	<b>Buzzer</b>
	Set options for buzzer sound during the machine operations.
	<b>Key Confirmation</b> Emit a sound when a key is pressed on the operation panel. <b>Value:</b> Off, On
	<b>Job Finish</b> Emit a sound when a print job is normally completed. <b>Value:</b> Off, On
	<b>Ready</b> Emit a sound when the warm-up is completed. <b>Value:</b> Off, On
	<b>Warning</b> Emit a sound when errors occur. <b>Value:</b> Off, On

## Display Bright. (Display Brightness)

 Status/  
System Menu/  
Counter
 ▶ Common Settings
▶ Display Bright.

Item	Description
<b>Display Bright.</b>	Set the brightness of the message display. <b>Value:</b> Lighter +3, Lighter +2, Lighter +1, Normal 0, Darker -1, Darker -2, Darker -3

## Quiet Mode



 Status/  
System Menu/  
Counter
 ▶ Common Settings
▶ Quiet Mode







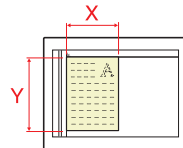
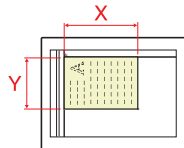
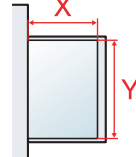
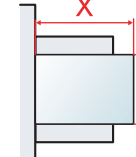

Item	Description
<b>Quiet Mode</b>	Make after-printing process run more quietly. Select this mode when the running noise is uncomfortable. <b>Value:</b> Off, On
	 <b>NOTE</b> When [On] is selected, preparation for the next printing may take longer.

## Orig./Paper Set. (Original/Paper Settings)

Status/  
System Menu/  
Counter

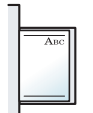
▶ Common Settings ▶ Orig./Paper Set.

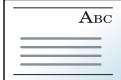
Item	Description
<b>Orig./Paper Set.</b>	<p>Set up frequently-used custom original size.</p> <p>To register a custom original size, enter the desired size. The custom size options are displayed on the screen to select original size.</p> <p><b>Value</b> X: Width / Y: Length</p> <p><b>Metric</b> X: 50 to 432 mm (in 1 mm increments) Y: 50 to 297 mm (in 1 mm increments)</p> <p><b>Inch</b> X: 2.00 to 17.00" (in 0.01" increments) Y: 2.00 to 11.69" (in 0.01" increments)</p> <div style="display: flex; justify-content: space-around;"> <div style="text-align: center;"> <p>Vertical</p>  </div> <div style="text-align: center;"> <p>Horizontal</p>  </div> </div>
<b>Custom PaperSize</b>	<p>Set up frequently-used custom paper size.</p> <p>To register a custom paper size, enter the desired size. The custom size option is displayed on the screen to select the paper size set in the multi purpose tray.</p> <p><b>Value</b> X: Width / Y: Length</p> <p><b>Metric</b> X: 148 to 432 mm (in 1 mm increments) Y: 98 to 297 mm (in 1 mm increments)</p> <p><b>Inch</b> X: 5.83 to 17.00" (in 0.01" increments) Y: 3.86 to 11.69" (in 0.01" increments)</p> <div style="display: flex; justify-content: space-around;"> <div style="text-align: center;"> <p>Vertical</p>  </div> <div style="text-align: center;"> <p>Horizontal</p>  </div> </div>
<b>Cassette 1 (to 4) Set.</b>	<p>Select the paper size and media type for cassettes. For information on how to select the paper size and media type, refer to <a href="#">Cassette 1 (to 4) Set. (Cassette 1 (to 4) Settings) on page 7-9.</a></p>
<b>MP Tray Set.</b>	<p>Select the paper size and media type for the multi purpose tray. For information on how to select the paper size and media type, refer to <a href="#">MP Tray Set. (MP Tray Settings) on page 7-9.</a></p>
<b>Media Type Set.</b>	<p>Set weight for each media type.</p> <p>For Custom 1-8, settings for duplex printing and media type name can be changed.</p> <p>For details on setting value, refer to <a href="#">Media Type Set. (Media Type Settings) on page 7-10.</a></p>
<b>Auto Detect Orig.</b>	<p>Select whether to automatically detect originals of special or non-standard size.</p> <p> <b>NOTE</b> For Auto Detect Orig., this change is available for some countries.</p>
	<p><b>A6/Hagaki</b></p> <p>As A6 and Hagaki are similar in size, select either one of them for automatic detection.</p> <p><b>Value: A6, Hagaki</b></p>
	<p><b>Folio</b></p> <p>Select whether to enable automatic detection of Folio.</p> <p><b>Value: Off, On</b></p>
	<p><b>11 × 15"</b></p> <p>Select whether to enable automatic detection of 11 × 15" size.</p> <p><b>Value: Off, On</b></p>

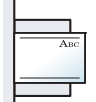
Item	Description
<b>Orig./ Paper Set.</b>	<p>Select a default media type for auto paper selection when [Auto] is selected of Paper Selection. If [Plain] is selected, the paper source with plain paper loaded in the specific size is selected. Select [All Media Types] for the paper source with any kind of paper loaded in the specific size.</p> <p><b>Value:</b> All Media Types, Plain, Transparency, Rough, Vellum, Labels, Recycled, Preprinted, Bond, Cardstock, Color, Prepunched, Letterhead, Envelope, Thick, High Quality, Custom 1-8</p>
<b>Def. PaperSource</b>	<p>Select paper cassette for default setting.</p> <p><b>Value:</b> Cassette 1 to 4, MP Tray</p> <p> <b>NOTE</b></p> <p>[Cassette 2], [Cassette 3] and [Cassette 4] are displayed when the optional paper feeder is installed.</p>
<b>SpicalPaper Act.</b>	<p>When printing on Prepunched, Preprint, and Letterhead, punch-holes might not be aligned or the print direction might be upside-down depending on how originals are set and the combination of copying functions. In such a case, select [Adj. PrintDirect] to adjust the print direction. When paper orientation is not important, select [Speed Priority].</p> <p>If [Adj. PrintDirect] is selected, load paper according to the steps below.</p> <p>Example: copying on Letterhead</p> <div style="display: flex; justify-content: space-around; align-items: flex-end; text-align: center;"> <div data-bbox="619 913 710 1064">  Original         </div> <div data-bbox="790 913 880 1064">  Paper         </div> <div data-bbox="960 913 1051 1064">  Finishing         </div> <div data-bbox="1131 913 1264 1064">  Cassette         </div> <div data-bbox="1343 913 1436 1064">  MP Tray         </div> </div> <div style="display: flex; justify-content: space-around; align-items: flex-end; text-align: center; margin-top: 10px;"> <div data-bbox="606 1131 726 1265">  Original         </div> <div data-bbox="774 1131 893 1265">  Paper         </div> <div data-bbox="941 1131 1061 1265">  Finishing         </div> <div data-bbox="1125 1120 1268 1265">  Cassette         </div> <div data-bbox="1348 1120 1444 1265">  MP Tray         </div> </div> <p><b>Value:</b> Adj. PrintDirect, Speed Priority</p>



### Cassette 1 (to 4) Set. (Cassette 1 (to 4) Settings)

Status/ System Menu/ Counter

▶ Common Settings ▶ Orig./Paper Set. ▶ **Cassette 1 (to 4) Set.**

To fix the type of paper to be used in cassettes 1 or the optional paper feeders (cassettes 2 to 4), specify the paper size and media type.

Item		Description
Cassette 1 (to 4) Set.	Cassette 1 (to 4) Size	Auto Paper size is automatically detected and selected. <b>Value:</b> Metric, inch
		Standard Size Available options are as follows: <b>Value:</b> A3, A4-R, A4, A5-R, B4, B5-R, B5, Folio, 216 × 340 mm, Ledger, Letter-R, Letter, Legal, Statement-R, Oficio II, 8K, 16K-R, 16K
	Cassette 1 (to 4) Type *1	Select the media type. <b>Value:</b> Plain (52 to 105 g/m <sup>2</sup> ), Rough, Vellum (52 to 105 g/m <sup>2</sup> ), Recycled, Preprinted*2, Bond, Color, Prepunched*2, Letterhead*2, Thick (106 to 128 g/m <sup>2</sup> ), High Quality, Custom 1-8

- \*1 To change to a media type other than [Plain], refer to [Media Type Set. on page 7-7](#). When the paper weight settings shown below are selected, the media indicated for each setting cannot be selected.  
 Plain, Preprinted, Recycled, Vellum, Rough, Letterhead, Color, Preprinted, High Quality: [Heavy 1], [Heavy 2] or [Extra Heavy]  
 Bond, Thick: [Heavy 2] or [Extra Heavy]  
 Custom 1 to 8: [Extra Heavy]
- \*2 To print on preprinted or prepunched paper or on letterhead, refer to [SpecialPaper Act. on page 7-8](#).

### MP Tray Set. (MP Tray Settings)

Status/ System Menu/ Counter

▶ Common Settings ▶ Orig./Paper Set. ▶ **MP Tray Set.**

To fix the type of paper to be used in the multi purpose tray, specify the paper size.

Item		Description
MP Tray Set.	MP Tray Size	Standard Size Available options are as follows: <b>Value:</b> A3, A4-R, A4, A5-R, A6-R, B4, B5-R, B5, B6-R, Folio, 216 × 340 mm, Ledger, Letter-R, Letter, Legal, Statement-R, Executive, Oficio II, 8K, 16K-R, 16K, ISO B5, Envelope #10, Envelope #9, Envelope #6, Envelope Monarch, Envelope DL, Envelope C5, Envelope C4, Hagaki, Oufukuhagaki, Youkei 4, Youkei 2, Custom*1
		Size Entry Enter the size not included in the standard size. <b>Value</b> X: Width / Y: Length <b>Metric</b> X: 148 to 432 mm (in 1 mm increments) Y: 98 to 297 mm (in 1 mm increments) <b>Inch</b> X: 5.83 to 17.00" (in 0.01" increments) Y: 3.86 to 11.69" (in 0.01" increments)
	MP Tray Type*2	Select the media type. <b>Value:</b> Plain (52 to 105 g/m <sup>2</sup> ), Transparency, Rough, Vellum (52 to 105 g/m <sup>2</sup> ), Labels, Recycled, Preprinted*3, Bond, Cardstock, Color, Prepunched*3, Letterhead*3, Envelope, Thick (106 to 163 g/m <sup>2</sup> ), High Quality, Custom 1-8

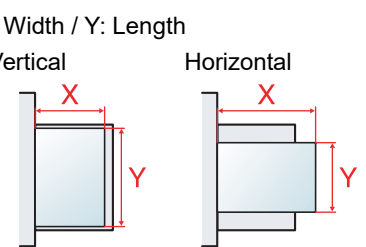

- \*1 For instructions on how to specify the custom paper size, refer to [Custom PaperSize on page 7-7](#).  
 \*2 To change to a media type other than [Plain], refer to [Media Type Set. on page 7-7](#).  
 \*3 To print on preprinted or prepunched paper or on letterhead, refer to [SpecialPaper Act. on page 7-8](#).

**Media Type Set. (Media Type Settings)**Status/  
System Menu/  
Counter**Common Settings****Orig./Paper Set.****Media Type Set.**

The following settings can be selected. Y (default): Default setting, Y: Available, N: Not available

Paper Weight	Light	Normal 1	Normal 2	Normal 3	Heavy 1	Heavy 2	Extra Heavy
<b>Weight (g/m<sup>2</sup>), Media Type</b>	52 g/m <sup>2</sup> to 59 g/m <sup>2</sup>	60 g/m <sup>2</sup> to 74 g/m <sup>2</sup>	75 g/m <sup>2</sup> to 90 g/m <sup>2</sup>	91 g/m <sup>2</sup> to 105 g/m <sup>2</sup>	106 g/m <sup>2</sup> to 128 g/m <sup>2</sup>	129 g/m <sup>2</sup> to 163 g/m <sup>2</sup>	Transparencies
<b>Plain</b>	Y	Y	Y (default)	Y	N	N	N
<b>Transparency</b>	N	N	N	N	Y <sup>*1</sup>	Y <sup>*1</sup>	Y <sup>*1</sup> (default)
<b>Rough</b>	Y	Y	Y	Y (default)	Y <sup>*1</sup>	Y <sup>*1</sup>	N
<b>Vellum</b>	Y (default)	Y	Y	Y	N	N	N
<b>Labels</b>	Y <sup>*1</sup>	Y <sup>*1</sup>	Y <sup>*1</sup>	Y <sup>*1</sup>	Y <sup>*1</sup> (default)	Y <sup>*1</sup>	Y <sup>*1</sup>
<b>Recycled</b>	Y	Y	Y (default)	Y	N	N	N
<b>Preprinted</b>	Y	Y	Y (default)	Y	N	N	N
<b>Bond</b>	Y	Y	Y	Y (default)	Y	Y <sup>*1</sup>	N
<b>Cardstock</b>	N	N	N	N	Y <sup>*1</sup>	Y <sup>*1</sup> (default)	Y <sup>*1</sup>
<b>Color</b>	Y	Y	Y (default)	Y	N	N	N
<b>Prepunched</b>	Y	Y	Y (default)	Y	N	N	N
<b>Letterhead</b>	Y	Y	Y (default)	Y	N	N	N
<b>Envelope</b>	N	N	N	N	Y <sup>*1</sup>	Y <sup>*1</sup> (default)	Y <sup>*1</sup>
<b>Thick</b>	N	N	N	N	Y	Y <sup>*1</sup> (default)	Y <sup>*1</sup>
<b>High Quality</b>	Y	Y	Y (default)	Y	N	N	N
<b>Custom 1 (to 8)</b>	Y	Y	Y (default)	Y	Y	Y	Y <sup>*1</sup>

\*1 The media type cannot be selected for the cassettes.

For Custom 1-8, settings for duplex printing and media type name can be changed.

Item		Description
Custom 1 (to 8)	Duplex	Select the setting for duplex. <b>Value</b> <b>Prohibit: Duplex printing not allowed.</b> <b>Permit: Duplex printing allowed.</b>
	Name	Change names for Custom 1-8. Names should be not more than 16 characters. Selecting media type at multi purpose tray, the name after change will be displayed.  <a href="#">Character Entry Method (page 10-4)</a>

## Preset Limit

 Status/  
System Menu/  
Counter
 ▶ Common Settings
▶ Preset Limit

Item	Description
<b>Preset Limit</b>	Restrict the number of copies that can be made at one time. <b>Value:</b> 1 to 999 copies

## Measurement

 Status/  
System Menu/  
Counter
 ▶ Common Settings
▶ Measurement

Item	Description
<b>Measurement</b>	Select inch or metric for the unit for paper dimensions. <b>Value:</b> mm, inch

## Error Handling

 Status/  
System Menu/  
Counter
 ▶ Common Settings
▶ Error Handling

Item	Description				
<b>Error Handling</b>	<table border="1" style="width: 100%; border-collapse: collapse;"> <tr> <td style="background-color: #e6f2ff; width: 20%;"><b>DuplexPaperError</b></td> <td>                             Set what to do when duplex printing is not possible for the selected paper sizes and media types.  <b>Value</b>  <b>1-sided: Printed in 1-sided</b>  <b>Display Error: Message to cancel printing is displayed.</b> </td> </tr> <tr> <td style="background-color: #e6f2ff;"><b>PaperMismatchErr</b></td> <td>                             Set what to do when the selected paper size or type does not match paper size or type loaded in the specified paper source while printing from the computer by specifying the cassette or multi-purpose tray.  <b>Value</b>  <b>Ignore: The setting is ignored and the job is printed.</b>  <b>Display Error: Message to cancel printing is displayed.</b> </td> </tr> </table>	<b>DuplexPaperError</b>	Set what to do when duplex printing is not possible for the selected paper sizes and media types. <b>Value</b> <b>1-sided: Printed in 1-sided</b> <b>Display Error: Message to cancel printing is displayed.</b>	<b>PaperMismatchErr</b>	Set what to do when the selected paper size or type does not match paper size or type loaded in the specified paper source while printing from the computer by specifying the cassette or multi-purpose tray. <b>Value</b> <b>Ignore: The setting is ignored and the job is printed.</b> <b>Display Error: Message to cancel printing is displayed.</b>
<b>DuplexPaperError</b>	Set what to do when duplex printing is not possible for the selected paper sizes and media types. <b>Value</b> <b>1-sided: Printed in 1-sided</b> <b>Display Error: Message to cancel printing is displayed.</b>				
<b>PaperMismatchErr</b>	Set what to do when the selected paper size or type does not match paper size or type loaded in the specified paper source while printing from the computer by specifying the cassette or multi-purpose tray. <b>Value</b> <b>Ignore: The setting is ignored and the job is printed.</b> <b>Display Error: Message to cancel printing is displayed.</b>				

## Timer Settings



Status/  
System Menu/  
Counter





Common Settings



Timer Settings

Configure settings related to the time.

	Item	Description
Timer Settings	Err. Clear Timer	<p>If you select [On] for Auto Error Clear, set the amount of time to wait before automatically clearing errors.</p> <p><b>Value: 5 to 495 seconds (in 5 second increments)</b></p> <p> <b>NOTE</b> This function is displayed when [Auto Err. Clear] is set to [On].</p>
	Sleep Timer	<p>Set amount of time before entering Sleep.</p> <p><b>Value</b> <b>For Europe: 1 to 60 minutes (1 minute increments)</b> <b>Except for Europe: 1 to 240 minutes (1 minute increments)</b></p> <p> <b>NOTE</b> Refer to <a href="#">Sleep and Sleep Timer on page 2-23</a> for Sleep.</p>
	PanelReset Timer	<p>If you select [On] for Auto Panel Reset, set the amount of time to wait before Auto Panel Reset.</p> <p><b>Value: 5 to 495 seconds (in 5 second increments)</b></p> <p> <b>NOTE</b> This function is displayed when [Auto Panel Reset] is set to [On].</p>
	Interrupt Clear	<p>Set the period after which the machine reverts to Normal mode when it has been set to Interrupt Copy mode and then left unused.</p> <p><b>Value: 5 to 495 seconds (in 5 second increments)</b></p>
	Power Off Rule	<p>Select whether to turn off the power automatically for the following function:</p> <ul style="list-style-type: none"> <li>• USB Cable</li> </ul> <p><b>Value: Off, On</b></p>
	Power Off Timer	<p>Select whether to turn off the power automatically after a period of inactivity.</p> <p><b>Value: 1 hour, 2 hours, 3 hours, 4 hours, 5 hours, 6 hours, 9 hours, 12 hours, 1 day, 2 days, 3 days, 4 days, 5 days, 6 days, 1 week</b></p>
	Auto Err. Clear	<p>If an error occurs during processing, processing stops to wait for the next step to be taken by the user. In the Auto Error Clear mode, automatically clear the error after a set amount of time elapses. For details, refer to <a href="#">Responding to Messages on page 9-11</a>.</p> <p><b>Value: Off, On</b></p>
	Auto Panel Reset	<p>If no jobs are run for a certain period of time, automatically reset settings and return to the default setting. Select to use Auto Panel Reset or not.</p> <p><b>Value: Off, On</b></p> <p> <b>NOTE</b> The time allowed to elapse before the panel is reset is set with the <a href="#">PanelReset Timer on page 7-12</a>.</p>

## Function Default

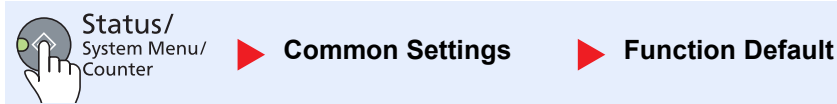

Set the defaults for the following functions.

Item	Description
<b>Function Default</b>	
<b>Original Image</b>	Set the default original document type. <b>Value:</b> Text+Photo, Photo, Text
<b>Zoom</b>	Select the enlarged/reduced default when paper size/sending size changed after the originals set. <b>Value:</b> 100%, Auto
<b>Collate/Offset</b>	Set the defaults for Collate/Offset. <b>Value</b> Off, Collate Only, Offset Each Page, Offset Each Set
<b>Orig. Orientation</b>	Set the original orientation defaults. <b>Value:</b> Top Edge on Top, Top Edge on Left
<b>Border Erase</b>	Set the default width to be erased as a border. <b>Value</b> <b>Metric:</b> 0 to 50 mm (in 1 mm increments) <b>Inch:</b> 0 to 2" (in 0.01" increments)  <b>NOTE</b> To specify border erase widths around original, set the value in [Border]. To specify border erase widths in the middle of original, set the value in [Gutter].
<b>Margin</b>	Set the default margin. <b>Value</b> <b>Metric</b> <b>Left/Right:</b> -18 to 18 mm (in 1 mm increments) <b>Top/Bottom:</b> -18 to 18 mm (in 1 mm increments) <b>Inch</b> <b>Left/Right:</b> -0.75 to 0.75" (in 0.01" increments) <b>Top/Bottom:</b> -0.75 to 0.75" (in 0.01" increments)
<b>Backgrnd Density</b>	Set the default Background Density (Copy). <b>Value:</b> Off, On
<b>EcoPrint</b>	Select the EcoPrint default. <b>Value:</b> Off, On
<b>Auto Rotation</b>	Select the default Auto Rotation setting. <b>Value:</b> Off, On
<b>File Name Entry</b>	Set an automatically entered name (default) for jobs. Additional information such as Job No. can also be set. <b>Value</b> <b>File Name Entry:</b> Up to 32 characters can be entered. <b>Additional Info:</b> None, Job No.
<b>Continuous Scan</b>	Set the continuous scan defaults. <b>Value:</b> Off, On

Item		Description
Function Default	Detail Settings	Set the defaults for the following detail settings:
	2 in 1 Layout	Set the default for the 2-in-1 layout of Combine copies. <b>Value:</b> L to R/T to B, R to L
	4 in 1 Layout	Set the default for the 4-in-1 layout of Combine copies. <b>Value:</b> Right then Down, Down then Right, Left then Down, Down then Left
	Border Line	Set the default for the border line of Combine copies. <b>Value:</b> None, Solid Line, Dotted Line, Positioning Mark
	Orig. Binding <sup>*1</sup>	Set the default for the binding orientation of two-sided originals to produce two-sided copies. <b>Value:</b> Left/Right, Top
	BookOrg. Binding	Set the default for the binding orientation of open book originals to produce two-sided copies. <b>Value:</b> Left, Right
Finish. Binding	Set the default for the binding orientation of finished two-sided copies. <b>Value:</b> Left/Right, Top	

\*1 Displayed only when the optional document processor is installed.

## Copy

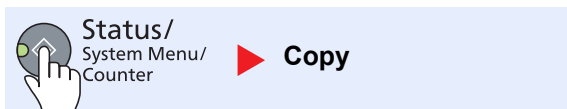

Configure settings for copying functions.

Item		Description
Copy	Paper Selection	Set the default paper selection. <b>Value:</b> Auto, Def. PaperSource
	AutoPaperSelect.	If [Auto] is selected for Paper Selection, set the paper size selection method when the zoom changes. <b>Value</b> <b>MostSuitableSize:</b> Selects paper size based on the current zoom and the size of the original. <b>Same as OrigSize:</b> Selects paper that matches the size of the original, regardless the zoom.
	Auto % Priority	When a paper source of different size from the original is selected, select whether automatic zoom (reduce/zoom) is performed. <b>Value:</b> Off, On

## Printer



When printing from computers, settings are generally made on the application software screen. However, the following settings are available for configuring the defaults to customize the machine.

Item		Description
<b>Printer</b>	<b>FormFeed TimeOut</b>	Receiving print data from the computer, the machine may sometimes wait if there is no information signaling that the last page does not have any more data to be printed. When the preset timeout passes, the machine automatically prints the document. The options are between 5 and 495 seconds. <b>Value: 5 to 495 seconds</b>

## Adjust/Maint. (Adjustment/Maintenance)

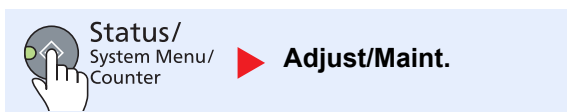

Adjust printing quality and conduct machine maintenance.

Item		Description
<b>Adjust/ Maint.</b>	<b>Density Adj.</b>	Adjust density.
	<b>Copy</b>	Adjust copy density. Adjustment can be made in 7 levels. <b>Value: Darker +3, Darker +2, Darker +1, Normal 0, Lighter -1, Lighter -2, Lighter -3</b>
	<b>Scan</b>	Adjust scan density. Adjustment can be made in 7 levels. <b>Value: Darker +3, Darker +2, Darker +1, Normal 0, Lighter -1, Lighter -2, Lighter -3</b>
	<b>Backgrnd Density</b>	Darkens or lightens overall background density adjustment.
	<b>Copy</b>	Darkens or lightens overall background density adjustment during copying. Adjustment can be made in 7 levels. <b>Value: Darker +3, Darker +2, Darker +1, Normal 0, Lighter -1, Lighter -2, Lighter -3</b>
	<b>Scan</b>	Darkens or lightens overall background density when scanning images. Adjustment can be made in 7 levels. <b>Value: Darker +3, Darker +2, Darker +1, Normal 0, Lighter -1, Lighter -2, Lighter -3</b>
	<b>Print Density</b>	Adjust print density. Adjustment can be made in 5 levels. <b>Value: 5 (Darker), 4, 3, 2, 1 (Lighter)</b>
	<b>Correct. Bk Line</b>	Correct fine lines (streaks caused by contamination), which may appear on the image, when the document processor is used. <b>Value</b> <b>Off: No correction performed.</b> <b>On: Correction performed. The reproduction of fine lines on the original may become lighter than when using [Off].</b>
	<b>Service Settings</b>	—
	<b>Drum Refresh</b>	Remove white lines from the image. Press the <b>[OK]</b> key and then select [Yes] to perform Drum Refresh.

# Default Settings on the PC (KYOCERA Client Tool)

Various machine settings can be configured from a computer using KYOCERA Client Tool. Install KYOCERA Client Tool from the provided Product Library disc.



## NOTE

- For the detailed functions of KYOCERA Client Tool, refer to **KYOCERA Client Tool User Guide**.
- KYOCERA Client Tool needs to be operated on the computer connected to the machine via USB.

## Operation Method

Configure the settings on the KYOCERA Client Tool as follows:

- 1 Access the KYOCERA Client Tool. For more information, refer to [Accessing KYOCERA Client Tool on page 2-19](#).
- 2 Select the desired tab.

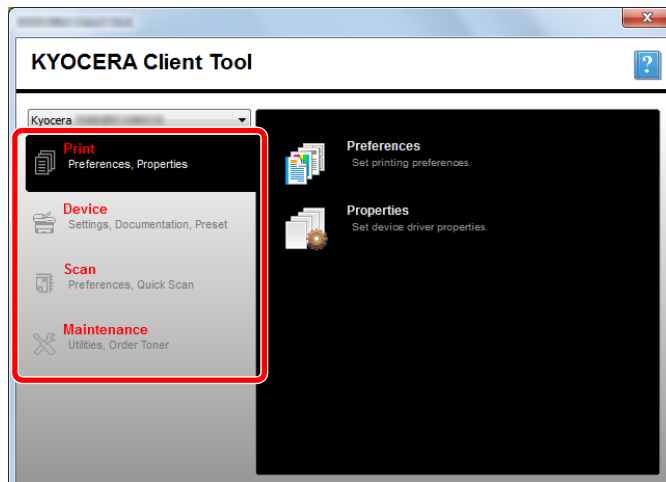

- 3 Configure the settings.







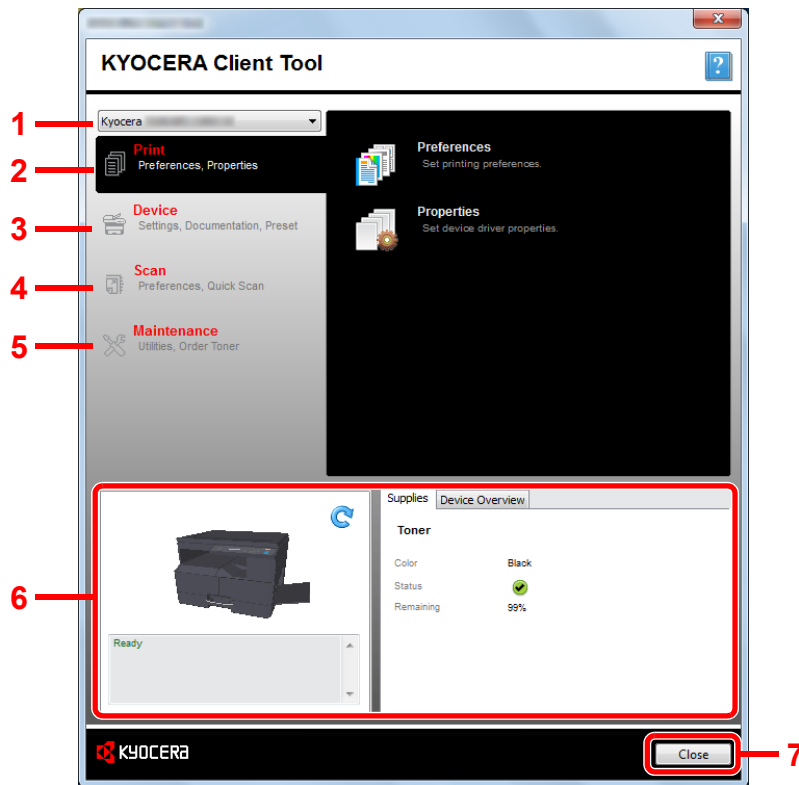

## Screen Overview

The screen overview of the KYOCERA Client Tool is as follows.



No.	Item	Description	Reference Page
1	Machine list	The list at the top of KYOCERA Client Tool screen includes all of the supported machines installed on your computer. You can select a machine from this list to view its properties and select available options, such as configuration, maintenance, and driver download.	—
2	Print	Access to printing preferences and machine driver properties.	—
	Preferences	Open the "Printing Preferences" screen for the selected machine.	—
	Properties	Open the "Properties" screen for the selected machine.	—
3	Device	Configure Status Monitor, Scan Destination, and Print Box settings.	—
	Configuration	Open the "Configuration" screen for the selected machine.	<a href="#">page 7-19</a>
	Scan Destination	Configure the Scan Destination settings.	<a href="#">page 7-20</a>
	Print Box Destination	Configure the Print Box settings.	<a href="#">page 7-26</a>

No.	Item	Description	Reference Page
4	<b>Scan</b>	Configure TWAIN and Quick Scan settings. Scan to PDF, Scan to Email and Scan to Folder can also be executed from this tab.	—
	<b>Preferences</b>	Open "TWAIN Driver" screen. Set the default value for the TWAIN scan.	<a href="#">page 7-23</a>
	<b>Quick Scan Settings</b>	Open "Quick Scan Settings" screen.	<a href="#">page 7-23</a>
	<b>Scan to PDF</b> 	This is one of the Quick Scan function. Performing this function saves the scanned image in PDF format.	<a href="#">page 5-35</a>
	<b>Scan to Email</b> 	This is one of the Quick Scan function. Performing this function attaches the scanned image to a new E-mail message.	<a href="#">page 5-35</a>
	<b>Scan to Folder</b> 	This is one of the Quick Scan function. Performing this function saves the scanned image to a specified folder.	<a href="#">page 5-35</a>
5	<b>Maintenance</b>	Order replacement toner, view our web site, and download software.	—
	<b>Order Toner</b> 	You can order replacement toner by e-mail or on the web. Click the [ <b>Order Toner</b> ] icon for these options: <ul style="list-style-type: none"> <li>Send e-mail Use the default e-mail address or type another e-mail address and then click [<b>OK</b>] to open your default e-mail program.</li> <li>Open Web page Use the default web address or type another web address and then click [<b>OK</b>] to open the web page in your default web browser.</li> </ul>	—
	<b>Kyocera Online</b> 	Open our website.	—
	<b>Driver Download</b> 	Click to open the download page of our website. You can download software and find an authorized dealer.	—
6	<b>Status Monitor</b>	You can check the current status of the machine.	<a href="#">page 6-11</a>
7	<b>Close</b>	Exit from KYOCERA Client Tool.	—

## Configuring the Administrative Settings

Configure the administrative settings on [[Configuration](#)] of the [[Device](#)] tab.

Configure screen has the followings tabs.

- [[Device Defaults](#)] tab: Select inches or millimeters as the unit of measurement for page sizes, watermark, poster, and gutter settings in the printer driver.
- [[Status Monitor](#)] tab: Select toner level alert and event notification settings for the Status Monitor. The Status Monitor displays device status messages.

Item	Description
<b>Set toner level alert</b>	Select to create an alert when the toner starts running low, and then select a percentage between 0 and 100. If the toner level goes below this percentage, an alert icon is displayed on the [ <a href="#">Supplies</a> ] tab at the bottom of KYOCERA Client Tool screen.
<b>Enable event notification</b>	Select to activate the notification feature for selected machine events. When selected, notification options are available.
<b>Enable pop-up notification</b>	When selected, a pop-up message appears in the lower right corner of the screen for each selected event as it occurs.
<b>Events list</b>	Select one or more events for the notification. To select all events, select [ <a href="#">Events</a> ].
<b>Sound file</b>	With one or more events selected, select to enable sound notification. Type the location of a sound file (.WAV), or click [ <a href="#">Browse</a> ] to find a sound file located on your computer. You can press the arrow button to hear the selected sound.
<b>Use Text to Speech</b>	With one or more events selected, select and type your preferred text. The Microsoft Text to Speech utility reads the text and plays it in a spoken voice. You can press the arrow button to hear the selected text.

## Scan Destination Settings











Configure the Scan Destination settings on [Scan Destination] of the [Device] tab.

### IMPORTANT







To reflect settings in the machine, the [Reset] key on the operation panel of the machine needs to be pressed.

### NOTE

Scan, Print Box, and device monitoring will be disabled while the [Scan] window is open.

Item	Description
<b>Destination number</b>	Select the destination number (1 to 10) to be registered. When a destination number is selected, the settings registered in that number appear in the right-hand screen.
<b>Summary</b>	Shows a list of the settings of the selected destination.
<b>Display name</b>	Set a name for the destination. Up to 16 characters can be entered. This name is displayed when you select a destination on the machine operation panel.
<b>Original size</b>	Specify the size of originals being scanned. <b>Value:</b> Auto, A3, A4, A5, A6, B4, B5 (JIS), B6, Folio, 216 × 340 mm, Ledger, Letter, Legal, Statement, 11 × 15", Oficio II, 8K, 16K, Hagaki, Oufuku Hagaki, Custom  <b>NOTE</b> Refer to <a href="#">Custom Orig.Size on page 7-7</a> for selecting [Custom].
<b>Original image</b>	Select image quality suited to the type of original. <b>Value:</b>    <b>Text + Photo</b> <b>Photo</b> <b>Text</b>
<b>Duplex*1</b>	Set duplex of original. <b>Value:</b>    <b>Off</b> <b>Binding left/right</b> <b>Binding top</b>
<b>Original orientation</b>	Select the orientation of the original document top edge to scan correct direction. <b>Value:</b>     <b>Landscape, Top edge left</b> <b>Landscape, Top edge top</b> <b>Portrait, Top edge left</b> <b>Portrait, Top edge top</b>
<b>Sharpen</b>	Adjust the sharpness of the image. <b>Value:</b> None, Low, Medium, High, Descreen (Blurs the outlines and reduces the sharpness.)
<b>Scan color</b>	Select the color mode setting. <b>Value:</b> Monochrome, Grayscale, Full color
<b>Density</b>	Select the density. <b>Value:</b> Lighter (-3), Lighter (-2), Lighter (-1), Normal (0), Darker (+1), Darker (+2), Darker (+3) To automatically set the density depending on the density of originals, select the [Auto] checkbox. (This item can be set only if [Monochrome] is set for Scan color.)

\*1 The optional document processor is required.

Item	Description
<b>Resolution</b>	Select fineness of scanning resolution. <b>Value:</b>     200×200 dpi    300×300 dpi    400×400 dpi    600×600 dpi  <b>NOTE</b> [400×400 dpi] and [600×600 dpi] can be set only if [Monochrome] is set for Scan color.
<b>Reverse image</b>	When this is selected, the image color reverses.
<b>File name</b>	Assign a document name to scanned images. When there are multiple pages, a three-digit incrementing number such as Scan_001, Scan_002... is appended to the end of the file name. Up to 16 characters can be entered.
<b>File format</b>	Specify the image file format. <b>Value:</b> BMP, JPEG, PNG, TIFF, PDF, "High Compression PDF, CCITT Group 4, Image Mask", "High Compression PDF, JBIG2, Mask +Image Mask"
<b>File format settings (The item displayed changes depending on the value specified for File format.)</b>	
<b>Quality</b>	Set the image quality. Increasing the number results in higher quality and decreasing the number results in lower quality. Higher quality will make the stored files larger. <b>Value:</b> 1 to 100  <b>NOTE</b> <ul style="list-style-type: none"> <li>• This setting is valid for PDF, TIFF, and JPEG file formats.</li> <li>• Non-numeric characters cannot be entered. If entered number is beyond range, the max/min value will be restored.</li> </ul>
<b>PDF/A-1</b>	Set PDF/A-1 format type. <b>Value:</b> Off, PDF/A-1a, PDF/A-1b
<b>High Compression PDF Quality</b>	Set the quality level for High Compression PDF. <b>Value:</b> Standard, Compression Ratio Priority, Quality Priority
<b>File separation<sup>*1</sup></b>	When this is selected, scanned data is separated into files page by page.

\*1 The optional document processor is required.

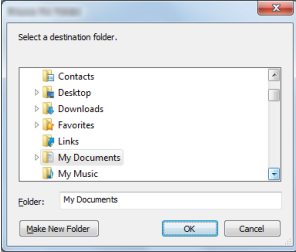
Item	Description
<p><b>Destination folder</b></p>	<p>Specified folder where the scanned image will be saved. To select the folder, click <b>[Browse]</b> to open "Browse for Folder".</p>  <p>The default settings are shown below: C:\Users\<user&gt;\documents< p=""> </user&gt;\documents<></p>
<p><b>Reset</b></p>	<p>Reset the destination to default values.</p>
<p><b>Save</b></p>	<p>Save your settings.</p>

## Quick Scan/TWAIN Settings

Configure the Quick Scan/TWAIN settings on [Preferences] or [Quick Scan Settings] of the [Scan] tab.

Item	Description
Preferences	Change the TWAIN scan settings. This setting is effective for Quick Scan only.
Quick Scan Settings	Change the settings for Scan to PDF, Scan to Email and Scan to Folder.

### TWAIN Settings

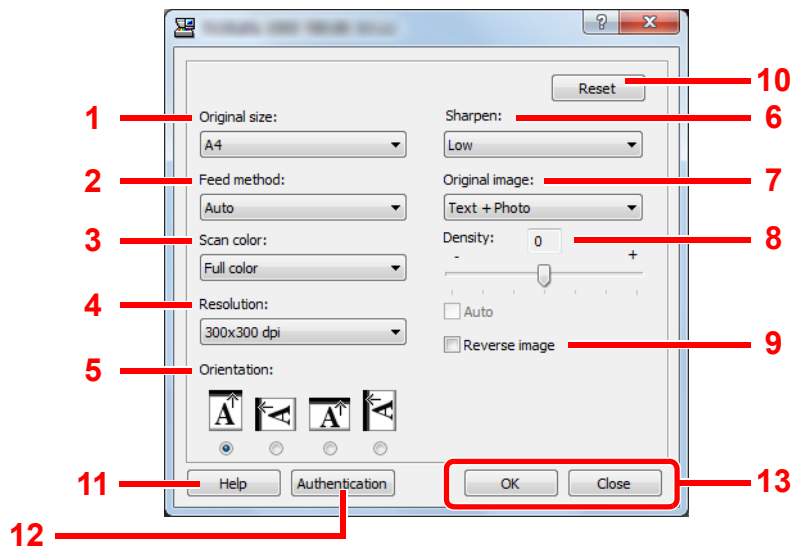

No.	Item	Description
1	Original size	Specify the size of originals being scanned. <b>Value:</b> Auto, A3, A4, A5, A6, B4, B5 (JIS), B6, Folio, 216 × 340 mm, Ledger, Letter, Legal, Statement, 11 × 15", Oficio II, 8K, 16K, Hagaki, Ofukuhagaki, Custom <b>NOTE</b> Refer to <a href="#">Custom Orig.Size on page 7-7</a> for selecting [Custom].
2	Feed method <sup>*1</sup>	Select the original feed method. <b>Value:</b> Auto, Document processor, Platen, 2-sided (Binding Top), 2-sided (Binding Left/Right)
3	Scan color	Select the color mode setting. <b>Value:</b> Monochrome, Grayscale, Full color
4	Resolution	Select fineness of scanning resolution. <b>Value:</b> 200 × 200 dpi, 300 × 300 dpi, 400 × 400 dpi, 600 × 600 dpi <b>NOTE</b> [400×400dpi] and [600×600dpi] can be set only if [Monochrome] is set for Scan color.
5	Orientation	Select the Orientation of the original document top edge to scan correct direction. <b>Value:</b> Portrait (Top Edge Top), Landscape (Top Edge Left), Landscape (Top Edge Top), Portrait (Top Edge Left)
6	Sharpen	Adjust the sharpness of the image. <b>Value:</b> None, Low, Medium, High, Descreen (Blurs the outlines and reduces the sharpness.)

\*1 The optional document processor is required.

No.	Item	Description
7	<b>Original image</b>	Select original image type. <b>Value:</b> Text, Photo, Text+Photo
8	<b>Destiny</b>	Select the density. <b>Value:</b> -3 (Lighter) to 3 (Darker) To automatically set the density depending on the density of originals, select the [Auto] checkbox. (This item can be set only if [Monochrome] is set for Scan color.)
9	<b>Reverse image</b>	When this is selected, the image color reverses.
10	<b>Reset</b>	Reset the settings to the previous settings.
11	<b>Help</b>	Displays the Help screen.
12	<b>Authentication</b>	Enter assigned account ID to manage the scan count accumulated of Quick Scan/TWAIN jobs by using job accounting.
13	<b>OK/Close</b>	Clicking [OK] exits the TWAIN Settings after applying the modified scan settings. Clicking [Close] exits the TWAIN Settings without applying the modified scan settings.

## Quick Scan Settings

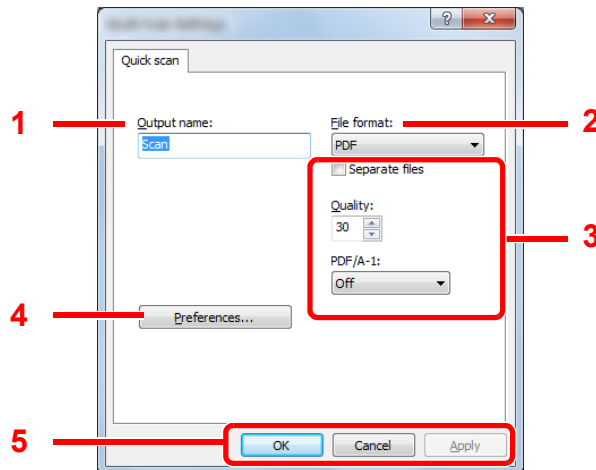

No.	Item	Description
1	<b>Output name</b>	Assign a document name to scanned images. When multiple images are saved in the same folder, a three-digit incrementing number such as Scan_001, Scan_002... is appended to the end of the file name. Up to 16 characters can be entered.
2	<b>File format</b>	Specify the image file format. <b>Value:</b> BMP, JPEG, PNG, TIFF, PDF, "High Compression PDF, CCITT Group 4, Image Mask", "High Compression PDF, JBIG2, Mask +Image Mask"



No.	Item	Description
3	<b>File format settings (The item displayed changes depending on the value specified for File format.)</b>	
	<b>Separate files</b>	When this is selected, scanned data is separated into files page by page.
	<b>Quality</b>	<p>Set the image quality. Increasing the number results in higher quality and decreasing the number results in lower quality. Higher quality will make the stored files larger.</p> <p><b>Value: 1 to 100</b></p> <p> <b>NOTE</b></p> <ul style="list-style-type: none"> <li>• This setting is valid for PDF, TIFF, and JPEG file formats.</li> <li>• Non-numeric characters cannot be entered. If entered number is beyond range, the max/min value will be restored.</li> </ul>
	<b>PDF/A-1</b>	<p>Set PDF/A-1 format type.</p> <p><b>Value: Off, PDF/A-1a, PDF/A-1b</b></p>
	<b>Quality Stage</b>	<p>Set the quality level for High Compression PDF.</p> <p><b>Value: Standard, Compression Ratio Priority, Quality Priority</b></p>
4	<b>Preferences</b>	Displays the TWAIN settings screen. For detail, refer to <a href="#">TWAIN Settings on page 7-23</a> .
5	<b>OK/Cancel/Apply</b>	<p>Clicking [<b>OK</b>] exits the Quick Scan Settings after applying the modified scan settings.</p> <p>Clicking [<b>Cancel</b>] exits the Quick Scan Settings without applying the modified scan settings.</p> <p>Clicking [<b>Apply</b>] applies the modified scan settings without exiting the Quick Scan Settings.</p>

## Print Box Settings

Configure the Print Box settings on [[Print Box Destination](#)] of the [[Device](#)] tab.



When KYOCERA Client Tool is installed, Print Boxes 1 to 10 are automatically created.

### IMPORTANT

- When sending a print job from the Client PC via a network, Box, Destination folder and PIN Code set by KYOCERA Client Tool need to be assigned to each Client PC.
- To reflect settings in the machine, the [[Reset](#)] key on the operation panel of the machine needs to be pressed.

### NOTE

Scan, Print Box, and device monitoring will be disabled while the [[Print Box](#)] window is open.

Item	Description
<b>Box number</b>	Select the box number (1 to 10) to be registered. When a box number is selected, the settings registered in that number appear in the right-hand screen.
<b>Summary</b>	Shows a list of the settings of the selected box.
<b>Name</b>	Set a name for the Print Box. Up to 16 characters can be entered. This name is displayed when you select a Print Box on the machine operation panel.   <b>NOTE</b> If a document is stored in the box for which no Box name is set, printing from the box is not available.
<b>PIN Code</b>	With a PIN code assigned to the Print Box, executing the print jobs in the Print Box from the machine requires entry of the PIN code, thereby restricting user access to the print jobs. Since third parties who do not know the PIN cannot print, security is enhanced. (Entering a password is not mandatory.) Select the checkbox to assign a PIN code to and enter a 4-digit numeric value.
<b>Destination folder</b>	Specify the path for the folder to be used as the Print Box. To select the folder, click [ <a href="#">Browse</a> ] to open "Browse for Folder".   <b>IMPORTANT</b> <b>The folder in the computer other than the computer connected to the machine via USB (Host PC) cannot be used as the destination folder.</b>
<b>Reset</b>	Reset the Print Box to default values.
<b>Save</b>	Save your settings.

# 8 Job Accounting

This chapter explains the following topics:

Overview of Job Accounting .....	8-2
Enabling Job Accounting .....	8-3
Setting an Account .....	8-4
Adding an Account .....	8-4
Restricting the Use of the Machine .....	8-6
Editing an Account .....	8-7
Deleting an Account .....	8-8
Job Accounting when Sharing the Printer .....	8-9
Unknown ID Job .....	8-11
Configuring Job Accounting .....	8-12
Default Setting .....	8-12
Counting the Number of Pages Printed .....	8-13
Account. Report (Accounting Report) .....	8-14
Using Job Accounting .....	8-15
Login/Logout .....	8-15
Printing When Sharing the Printer .....	8-15

# Overview of Job Accounting

Job accounting manages the copy/print/scan count accumulated by individual accounts by assigning an ID to each account.

- 1** Enable job accounting. (Refer to [page 8-3.](#))
- 2** Setting an account. (Refer to [page 8-4.](#))
- 3** Enter the assigned account ID when performing the job. (Refer to [Using Job Accounting on page 8-15.](#))
- 4** Count the number of pages copied, printed and scanned.

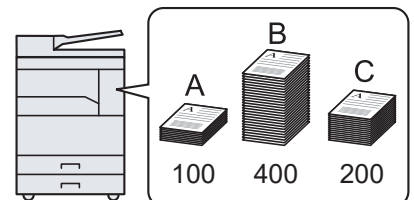
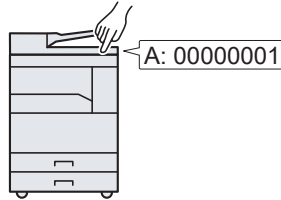
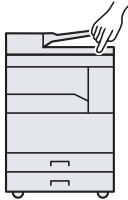

## To manage the print job account by using the machine as the shared printer

To manage the print job account by using the machine as the shared printer, you need to configure the printer settings on the computer (Host PC) connected to the machine via USB.

- 1** Set the job accounting of the shared printer by using the Host PC. (Refer to [Job Accounting when Sharing the Printer on page 8-9.](#))
- 2** Enter the Account ID from the Client PC and execute printing. (Refer to [Printing When Sharing the Printer on page 8-15.](#))
- 3** Count the number of pages printed.

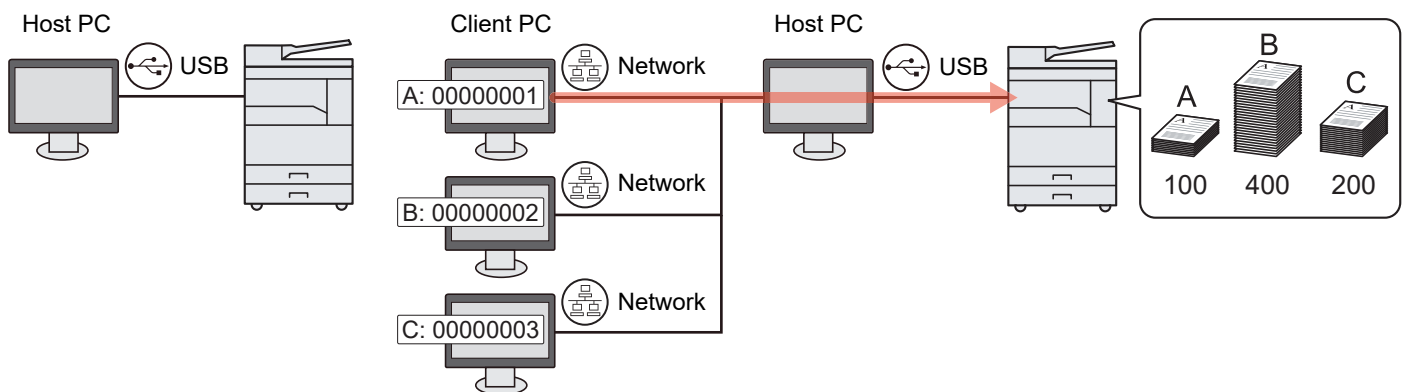

### NOTE

When using the machine as a shared printer, settings must be made for the shared printer. Refer to [Setting the Shared Printer on page 2-17.](#)

## To manage the scan job account by using Quick Scan/TWAIN

To manage the scan job account by using Quick Scan or TWAIN, you need to configure KYOCERA Client Tool settings on the computer (Host PC) connected to the machine via USB. (Refer to [Default Settings on the PC \(KYOCERA Client Tool\) on page 7-16.](#))

## To manage the scan job account by using WIA

To manage the scan job account by using WIA, you need to configure the WIA driver settings on the computer (Host PC) connected to the machine via USB. (Refer to [Setting WIA Driver on page 2-20.](#))

# Enabling Job Accounting

Enable job accounting. Use the procedure below.

## 1 Access job accounting setting.

- 1 Press the [**Status/System Menu/Counter**] key.



- 2 Press the [**▲**] or [**▼**] key to select [Admin/Accounting], and press the [**OK**] key.

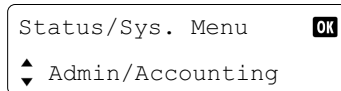

### NOTE

If the login user name entry screen appears during operations, log in by referring to [Administrator User Name and Password on page 2-21](#).

The factory default login user name and login password are set as shown below.

Login User Name	Login Password
Admin*1	Admin*1

\*1 Upper case and lower case letters are distinguished (case sensitive).

- 3 Press the [**▲**] or [**▼**] key to select [Job Account. Set.], and press the [**OK**] key.

## 2 Enable job accounting.

- 1 Press the [**▲**] or [**▼**] key to select [Job Accounting], and press the [**OK**] key.
- 2 Press the [**▲**] or [**▼**] key to select [On], and press the [**OK**] key.

### NOTE

- To disable job accounting, select [Off].
- If job accounting setting is completed by selecting other function keys, such as the [**Copy**] key, a logout is automatically executed and the screen to enter the Account ID appears. To continue the operation, enter the Account ID.

# Setting an Account

You can add, change and delete an account and set the restriction for each account.

## Adding an Account

Up to 10 individual accounts can be added. The following entries are required.

Item	Descriptions
Account Name	Enter the account name (up to 32 characters).
Account ID	Enter the account ID as many as eight digits (between 0 and 99999999).
Restriction	This prohibits printing/scanning or restricts the number of sheets to load. Refer to <a href="#">Restricting the Use of the Machine on page 8-6</a> .

### 1 Display the screen.

- 1 Press the [**Status/System Menu/Counter**] key.



- 2 Press the [**▲**] or [**▼**] key to select [Admin/Accounting], and press the [**OK**] key.

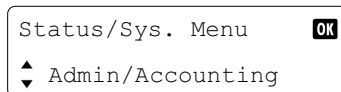

#### NOTE

If the login user name entry screen appears during operations, log in by referring to [Administrator User Name and Password on page 2-21](#).

The factory default login user name and login password are set as shown below.

Login User Name	Login Password
Admin*1	Admin*1

\*1 Upper case and lower case letters are distinguished (case sensitive).

- 3 Press the [**▲**] or [**▼**] key to select [Job Account. Set.], and press the [**OK**] key.
- 4 Press the [**▲**] or [**▼**] key to select [Account. List], and press the [**OK**] key.

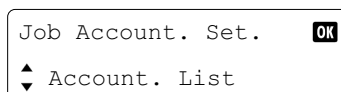

- 5 Press the [**▲**] or [**▼**] key to select [Add Account], and press the [**OK**] key.

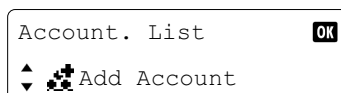

## 2 Enter the account information.

- 1 Enter the account name and press the [OK] key.

   
▲ ▼

### NOTE

Refer to [Character Entry Method on page 10-4](#) for details on entering characters.

- 2 Enter the account ID and press the [OK] key.

   
▲ ▼

A new account is added on the Account List.

### NOTE

Any "Account ID" that has already registered cannot be used. Enter any other account ID.

- 3 To apply restriction to the account ID, press the [▲] or [▼] key to select [Detail] and press the [OK] key.

To exit the operation, press the [▲] or [▼] key to select [Exit] and press the [OK] key.

   
▲ Detail ▼

[Restricting the Use of the Machine \(page 8-6\)](#)

## Restricting the Use of the Machine

This section explains how to restrict the use of the machine by account or the number of sheets available.

The items that can be restricted differ depending on whether [Split] or [Total] is selected for [Copy/Print Count on page 8-12](#).

- [Split] selected for Copy/Printer Count

Item	Descriptions
<b>Copy Restrict.</b>	Limits the number of sheets used for copying. <b>Value</b> <b>Off: No restriction is applied.</b> <b>Counter Limit: Restricts the counter in one-page increments up to 9,999,999 copies. *1</b> <b>Reject Usage: Restriction is applied.</b>
<b>Print Restrict.</b>	Limits the number of sheets used for printing. <b>Value</b> <b>Off: No restriction is applied.</b> <b>Counter Limit: Restricts the counter in one-page increments up to 9,999,999 copies. *1</b> <b>Reject Usage: Restriction is applied.</b>
<b>Scan Restrict.</b>	Limits the number of sheets scanned (excludes copying). <b>Value</b> <b>Off: No restriction is applied.</b> <b>Counter Limit: Restricts the counter in one-page increments up to 9,999,999 copies. *1</b> <b>Reject Usage: Restriction is applied.</b>

- [Total] selected for Copy/Printer Count

Item	Descriptions
<b>Print Restrict.</b>	Limits the total number of sheets used for copying and printing. <b>Value</b> <b>Off: No restriction is applied.</b> <b>Counter Limit: Restricts the counter in one-page increments up to 9,999,999 copies. *1</b> <b>Reject Usage: Restriction is applied.</b>
<b>Scan Restrict.</b>	Limits the number of sheets scanned (excludes copying). <b>Value</b> <b>Off: No restriction is applied.</b> <b>Counter Limit: Restricts the counter in one-page increments up to 9,999,999 copies. *1</b> <b>Reject Usage: Restriction is applied.</b>

\*1 If [Counter Limit] is selected, the [Limit Pages] screen appears after the [OK] key is pressed. Enter a counter limit on pages using the numeric keys, and press the [OK] key.



# Editing an Account

This changes the registered account information.

## 1 Display the screen.

- 1 Press the [**Status/System Menu/Counter**] key.



- 2 Press the [**▲**] or [**▼**] key to select [Admin/Accounting], and press the [**OK**] key.

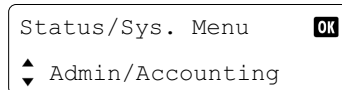

### NOTE

If the login user name entry screen appears during operations, log in by referring to [Administrator User Name and Password on page 2-21](#).

The factory default login user name and login password are set as shown below.

Login User Name	Login Password
Admin*1	Admin*1

\*1 Upper case and lower case letters are distinguished (case sensitive).

- 3 Press the [**▲**] or [**▼**] key to select [Job Account. Set.], and press the [**OK**] key.
- 4 Press the [**▲**] or [**▼**] key to select [Account. List], and press the [**OK**] key.

## 2 Change account information.

- 1 Press the [**▲**] or [**▼**] key to select the account you want to change and press the [**OK**] key.

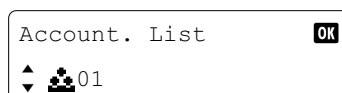

- 2 Press the [**▲**] or [**▼**] key to select [Detail/Edit], and press the [**OK**] key.
- 3 Refer to step 2 of [Adding an Account on page 8-4](#) and [Restricting the Use of the Machine on page 8-6](#) to change account information.

# Deleting an Account

This deletes the account.

## 1 Display the screen.

- 1 Press the [Status/System Menu/Counter] key.



- 2 Press the [▲] or [▼] key to select [Admin/Accounting], and press the [OK] key.

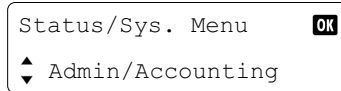

### NOTE

If the login user name entry screen appears during operations, log in by referring to [Administrator User Name and Password on page 2-21](#).

The factory default login user name and login password are set as shown below.

Login User Name	Login Password
Admin*1	Admin*1

\*1 Upper case and lower case letters are distinguished (case sensitive).

- 3 Press the [▲] or [▼] key to select [Job Account. Set.], and press the [OK] key.
- 4 Press the [▲] or [▼] key to select [Account. List], and press the [OK] key.

## 2 Delete an account.

- 1 Press the [▲] or [▼] key to select the account you want to delete and press the [OK] key.

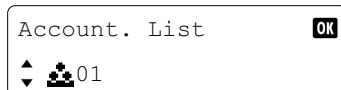

- 2 Press the [▲] or [▼] key to select [Delete], and press the [OK] key.
- 3 Press the [▲] or [▼] key to select [Yes] in the confirmation screen, and press the [OK] key.  
The account is deleted.

# Job Accounting when Sharing the Printer

When using the machine as the shared printer, printing from the computer (Client PC) on the network can be managed with job accounting by configuring job accounting for the computer (Host PC) connected to the machine via USB.

## Settings when Sharing the Printer

When using the machine as a shared printer and managing the printing from the Client PC by using job accounting, configure the Host PC as follows.

### 1 Display the screen.

- 1 Click **[Start]** button on the Windows and then select **[Windows System]**, **[Control Panel]**, and **[View devices and printers]**.

In Windows 8.1, select **[Settings]** in charms on Desktop, and select **[Control Panel]**, and then **[Devices and Printers]**.

- 2 Right-click the printer driver icon of the machine, and click the **[Printer properties]** menu of the printer driver.

- 3 Click **[Administrator]** on the **[Device Settings]** tab.

### 2 Configure the settings.

- 1 Select **[Password protect administrator settings]** on the **[General]** tab. The "Password" window appears.

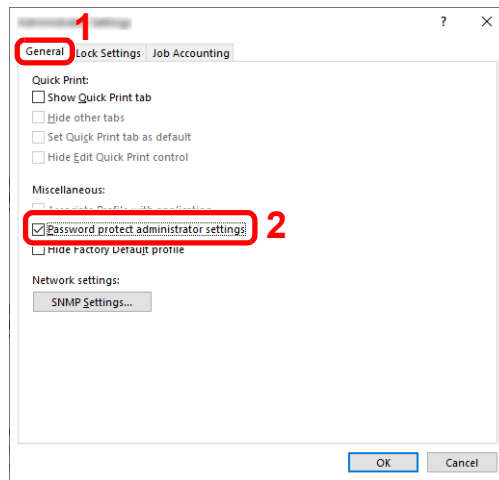

- 2 Enter the same password (optional) in **[Password]** and **[Confirm password]**, and then click **[OK]**.

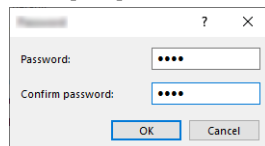

The password is required for opening the Administrator Settings window.

3 Select [**Job accounting**] and [**Prompt for account ID**] on the [**Job Accounting**] tab.

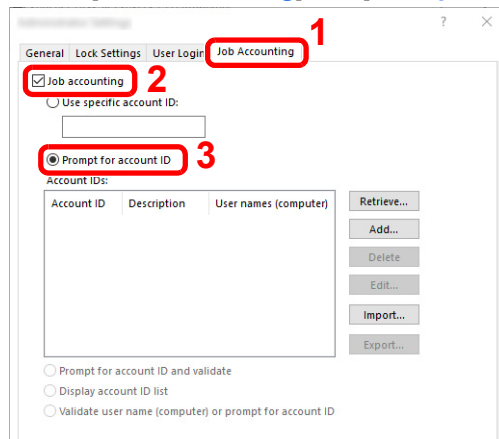

4 Click the [**OK**] button.

 **NOTE**

- If [**Prompt for account ID**] is set, the screen for entering the Account ID appears when printing from the Client PC. When printing from the Client PC, refer to [Printing When Sharing the Printer on page 8-15](#).
- For other settings of job accounting, refer to **Printer Driver User Guide**.

## Unknown ID Job

This specifies the behavior for handling the jobs sent with unknown account IDs (i.e., unsent IDs). The setting items are as follows.

Item	Descriptions
Permit	The job is permitted to be printed.
Reject	The job is rejected (not printed).

### 1 Display the screen.

- 1 Press the [**Status/System Menu/Counter**] key.



- 2 Press the [**▲**] or [**▼**] key to select [Admin/Accounting], and press the [**OK**] key.

#### NOTE

If the login user name entry screen appears during operations, log in by referring to [Administrator User Name and Password on page 2-21](#).

The factory default login user name and login password are set as shown below.

Login User Name	Login Password
Admin*1	Admin*1

\*1 Upper case and lower case letters are distinguished (case sensitive).

### 2 Configure the settings.

- 1 Press the [**▲**] or [**▼**] key to select [Unknown ID Job], and press the [**OK**] key.
- 2 Press the [**▲**] or [**▼**] key to select [Permit] or [Reject], and press the [**OK**] key.

# Configuring Job Accounting

## Default Setting

Set the defaults for job accounting. To configure the settings, select the item in Default Setting and press the setting item.

Status/  
System Menu/  
Counter
▶ Admin/Accounting
▶ Job Account. Set.
▶ Default Setting

For details on each function, see the table below.

Item	Description
<b>Apply Limit</b>	<p>This specifies how the machine behaves when the counter has reached the limit of restriction. The table below describes the action taken.</p> <p><b>Value</b></p> <p><b>Immediately: Job stops when the counter reaches its limit.</b></p> <p><b>Subsequently: Printing/scanning of the job continues but the subsequent job will be rejected.</b></p> <p><b>Alert Only: Job continues while displaying an alert message.</b></p>
<b>Copy/Print Count</b>	<p>You can select how the copying and printing page counts are shown - either the total of both or each of copying and printing individually (Split). The selection may influence restriction on the count and count method. For details, refer to <a href="#">Restricting the Use of the Machine (page 8-6)</a> and <a href="#">Account. Report (Accounting Report) (page 8-14)</a>.</p> <p><b>Value: Total, Split</b></p>
<b>Counter Limit</b>	<p>When you add a new account, you can change the default restrictions on the number of sheets used. You can set any number from 1 to 9,999,999.</p> <p>The items that can be set differ depending on whether [Split] or [Total] is selected for [Copy/Print Count].</p>
<b>[Split] selected for Copy/Printer Count</b>	
<b>Copy Restrict.</b>	Sets the default restriction on the number of sheets used for copying.
<b>Print Restrict.</b>	Sets the default restriction on the number of sheets used for printing.
<b>ScanRest.(Others)</b>	Sets the default restriction on the number of sheets used for scanning (excludes copying).
<b>[Total] selected for Copy/Printer Count</b>	
<b>Print Restrict.</b>	Sets the default restriction on the total number of sheets used for copying and printing.
<b>ScanRest.(Others)</b>	Sets the default restriction on the number of sheets used for scanning (excludes copying).
<b>Cnt by PaperSize</b>	<p>This counts the number of pages by paper size (e.g. Letter).</p>
<b>Paper Size 1 (to 5)</b>	<p>In addition to paper size, media type can also be specified (e.g. count the letter-size color paper used). If you do not specify the media type, the number of used sheets will be counted for the specified sheet size, regardless of the media type.</p> <p> <b>NOTE</b></p> <p>Paper size is available in five types, 1 to 5. These types are specified in accounting reports. Refer to <a href="#">Account. Report (Accounting Report) on page 8-14</a>.</p> <p><b>Value: Off, On</b></p> <p><b>Paper Size: A3, A4, A5, B4, B5, Folio, Ledger, Legal, Letter, Statement</b></p> <p><b>Media Type: All Media Type, Plain, Transparency, Rough, Vellum, Labels, Recycled, Preprinted, Bond, Cardstock, Color, Prepunched, Letterhead, Envelope, Thick, High Quality, Custom 1 to 8</b></p>

## Counting the Number of Pages Printed

This counts the number of pages printed. Counts are classified into Total Job Accounting and Each Job Accounting. A new count can also be started after resetting the count data which was stored for a certain period of time.



### Total Accounting

This counts the number of pages for all accounts and resets the counts for those accounts together at the same time.

### Each Job Accounting

This counts the number of pages for each account and resets the counts by account. When checking Each Job Accounting, select the account for which you want to check the count.

Types of the counts are as follows.

Item	Descriptions
<b>Printed Pages</b>	Displays the number of pages copied and printed, and the total number of pages used. You can also use [Duplex Pages] and [Combine Pages] to check the number of pages used.
<b>Copy/Print Pages</b>	Displays the number of pages copied and printed, and the total number of pages used. Press the [▲] or [▼] key to switch the screens.
<b>Total Print Pages</b>	Displays the total number of pages used for copying and printing.
<b>Duplex Pages</b>	Displays the number of pages printed in [1-Sided] mode, [2-Sided] mode, and the total pages in both modes. Press the [▲] or [▼] key to switch the screens.
<b>Combine Pages</b>	Displays the number of pages printed in [None] (no Combine) mode, [2 in 1] mode, [4 in 1] mode, and the total pages in both modes. Press the [▲] or [▼] key to switch the screens.
<b>Cnt by PaperSize</b>	Displays the number of pages used in the selected paper size as well as the number of pages used in other paper sizes. Press the [▼] key to view the next screen. Press the [▲] key to return to the previous screen.
<b>Scanned Pages</b>	Displays the number of pages scanned for copying and other functions, as well as the total number of pages scanned. Press the [▲] or [▼] key to switch the screens.
<b>Counter Reset</b>	Resets the counter. Press the [▲] or [▼] key to select [Yes] in the confirmation screen, and press the [OK] key.

To check other items, press the [Back] key to return to the previous screen.

## Account. Report (Accounting Report)

The total pages counted of all relevant accounts can be printed as an accounting report. Reports have different formats depending on how the count of copiers and printers is administered.

### When [Split] is selected for Managing the Copy/Printer Count

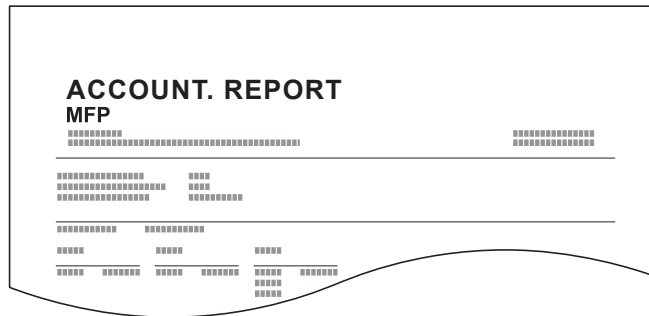

For the count by paper size, the report will be printed by size.

Use the procedure below to print a job accounting report.

### 1 Prepare paper.

Check that A4 or Letter paper is loaded in the cassette.

### 2 Display the screen.

1 Press the [Status/System Menu/Counter] key.



2 Press the [▲] or [▼] key to select [Admin/Accounting], and press the [OK] key.

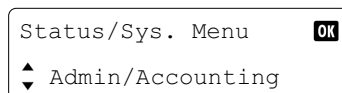

#### NOTE

If the login user name entry screen appears during operations, log in by referring to [Administrator User Name and Password on page 2-21](#).

The factory default login user name and login password are set as shown below.

Login User Name	Login Password
Admin*1	Admin*1

\*1 Upper case and lower case letters are distinguished (case sensitive).

3 Press the [▲] or [▼] key to select [Job Account. Set.], and press the [OK] key.

### 3 Print the report.

1 Press the [▲] or [▼] key to select [Account. Report], and press the [OK] key.

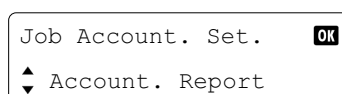

2 Press the [▲] or [▼] key to select [Yes], and press the [OK] key.

Accounting report is printed.



# Using Job Accounting

This section explains procedures while setting job accounting.

## Login/Logout

If job accounting is enabled, an account ID entry screen appears each time you use this machine. Use the procedure below to login and logout.

### Login

- 1 In the screen below, enter the account ID using the numeric keys and press the **[OK]** key.

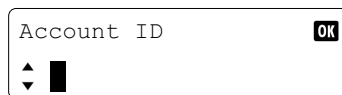

#### NOTE

- If you entered a wrong character, press the **[Clear]** key and enter the account ID again.
- If the entered account ID does not match the registered ID, a warning beep will sound and login will fail. Enter the correct account ID.

- 2 Proceed to complete the rest of the steps.

### Logout

When the operations are complete, press the **[Logout]** key to return to the account ID entry screen.

Logout



## Printing When Sharing the Printer

If the following account ID entry screen appears when printing from your PC, enter the assigned Account ID and then click the **[OK]** button to continue printing.

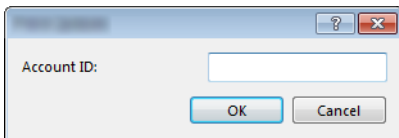

[Settings when Sharing the Printer \(page 8-9\)](#)

# 9 Troubleshooting

This chapter explains the following topics:

Regular Maintenance .....	9-2
Cleaning .....	9-2
Toner Container Replacement .....	9-3
Waste Toner Box Replacement .....	9-6
Troubleshooting .....	9-8
Solving Malfunctions .....	9-8
Responding to Messages .....	9-11
Clearing Paper Jams .....	9-16

# Regular Maintenance

## Cleaning

Clean the machine regularly to ensure optimum printing quality.



### CAUTION

For safety, always unplug the power cord before cleaning the machine.

### Original Cover/Glass Platen

Wipe the backside of the original cover, the inside of the document processor and the glass platen with a soft cloth dampened with alcohol or mild detergent.



### IMPORTANT

Do not use thinner or other organic solvents.

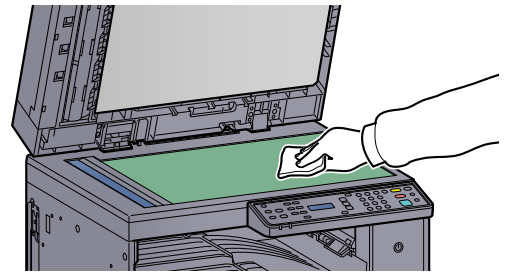
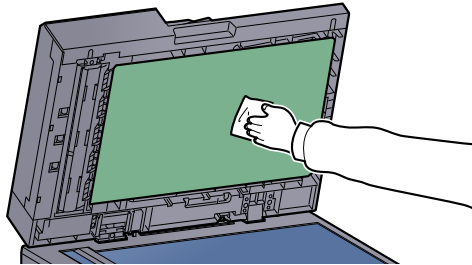

### Slit Glass

When using the document processor, clean the slit glass surface and the reading guide with the dry accessory cloth. Dirt on the slit glass or the reading guide may cause black streaks to appear in the output.



### IMPORTANT

Do not use water, soap or solvents for cleaning.

1

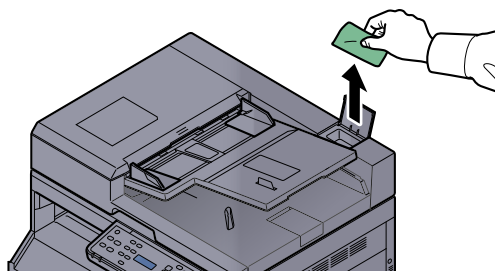

2

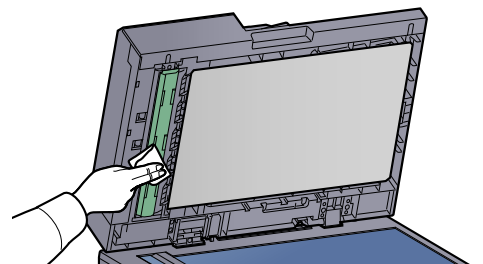
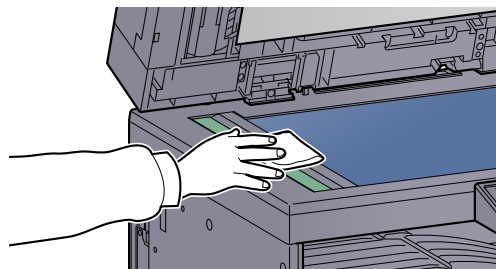

## Toner Container Replacement

When toner runs low, [Toner is low.] appears in the message display. Make sure you have a new toner container available for replacement.

When the message display displays [Add toner.], replace the toner.



### CAUTION

Do not attempt to incinerate parts which contain toner. Dangerous sparks may cause burns.



### NOTE

- For the toner container, always use a genuine toner container. Using a toner container that is not genuine may cause image defects and product failure.
- The memory chip in the toner container of this product stores information necessary for improving customer convenience, operation of the recycling system for used toner containers, and planning and development of new products. The stored information does not include information that makes it possible to identify individuals, and is only used anonymously for the above purposes.

1

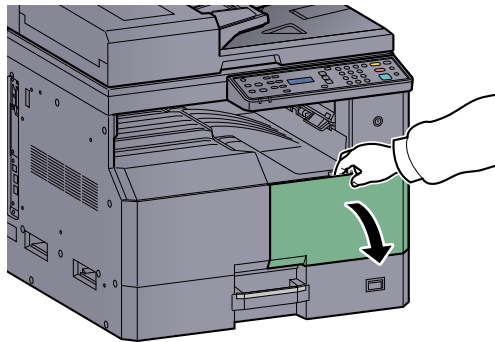

2

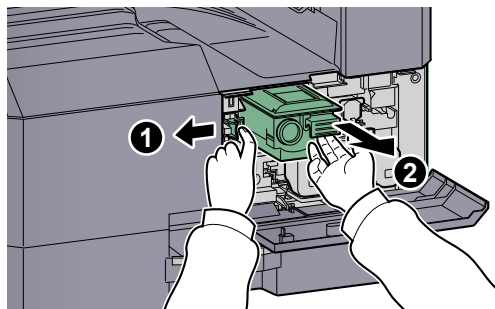

3

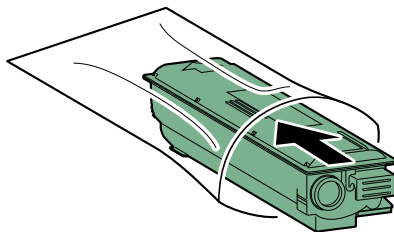

4

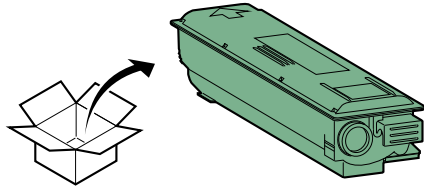

✔ IMPORTANT

Shake the toner container according to the procedure and place the container in position.

5

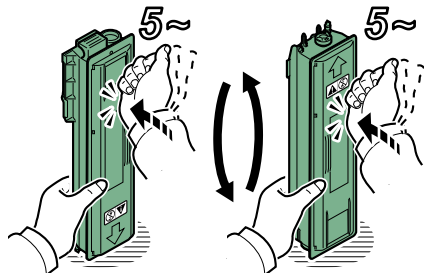

6

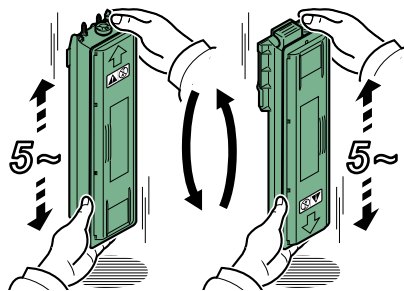

7

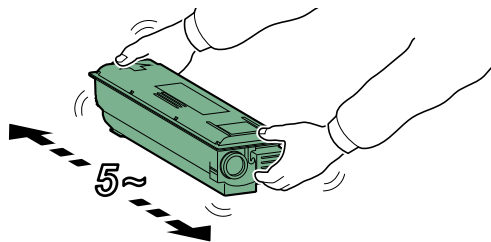

8

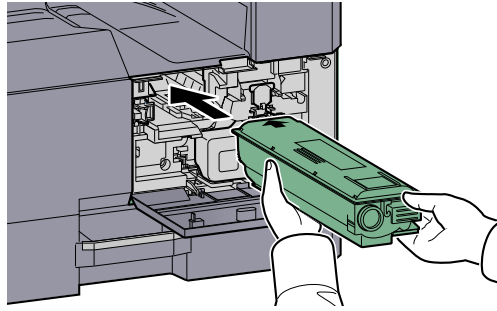

9

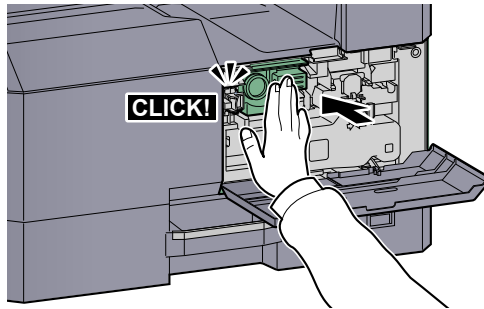

10

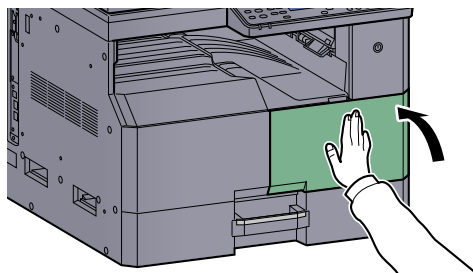

**NOTE**

Return the exhausted toner container and waste toner box to your dealer or service representative. The collected toner container and waste toner box will be recycled or disposed in accordance with the relevant regulations.

## Waste Toner Box Replacement

When replacing the toner container, replace the waste toner box as well. You also need to replace the waste toner box when [WasteTonerBox is full or not installed.] is displayed on the message display.



### CAUTION

Do not attempt to incinerate parts which contain toner. Dangerous sparks may cause burns.

1

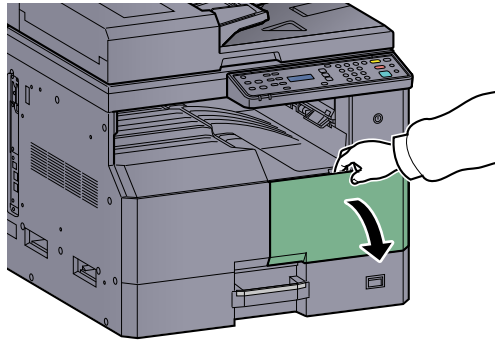

2

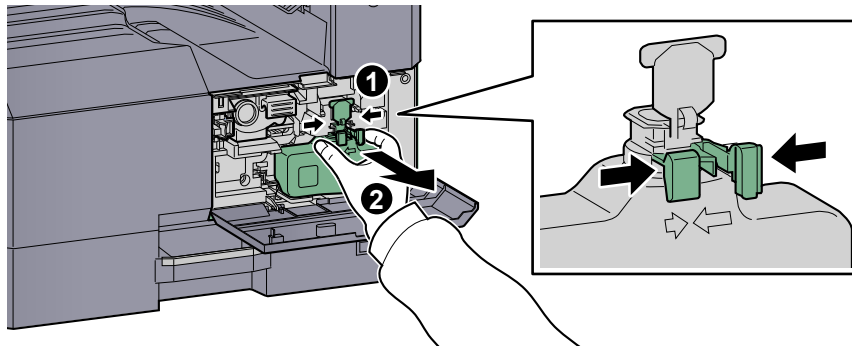

3

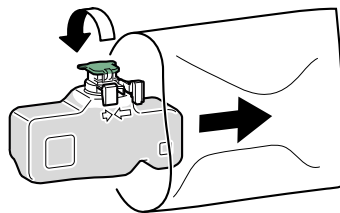

4

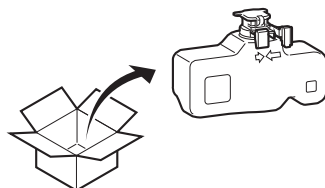

5

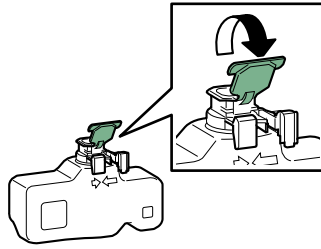

6

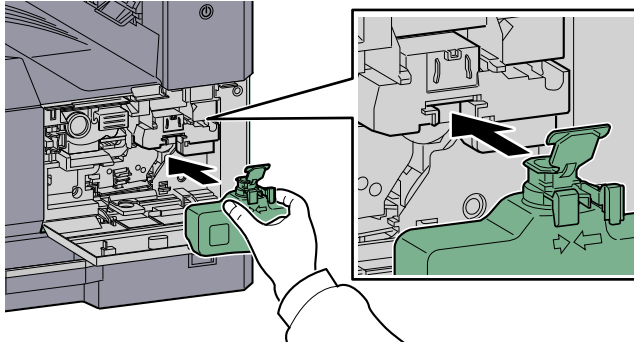

7

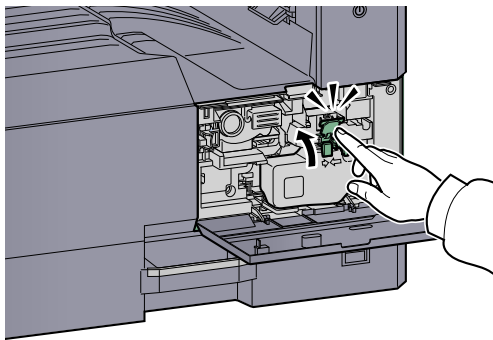

8

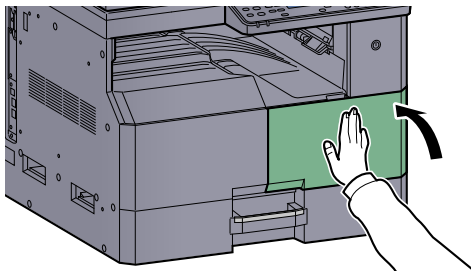

**NOTE**

Return the exhausted toner container and waste toner box to your dealer or service representative. The collected toner container and waste toner box will be recycled or disposed in accordance with the relevant regulations.







# Troubleshooting



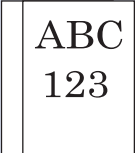
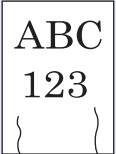

## Solving Malfunctions

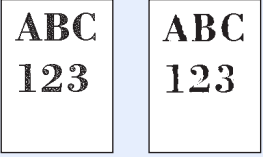
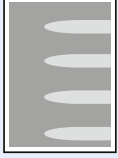
The table below provides general guidelines for problem solving.

If a problem occurs with your machine, look into the checkpoints and perform procedures indicated on the following pages. If the problem persists, contact your Service Representative.

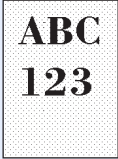
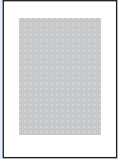
Symptom	Checkpoints	Corrective Actions	Reference Page
The screen does not respond when the power switch is turned on.	Check the power cord.	Connect both ends of the power cord securely.	<a href="#">page 2-7</a>
Pressing the [Start] key does not produce copies.	Is there a message on the screen, KYOCERA Client Tool, or the Status Monitor?	Determine the appropriate response to the message and respond accordingly.	<a href="#">page 9-11</a>
	Is the machine in Sleep mode?	Press any key on the operation panel to recover the machine from Sleep mode.	<a href="#">page 2-23</a>
Blank sheets are ejected. 	Are the originals loaded correctly?	When placing originals on the platen, place them face-down and align them with the original size indicator plates.	<a href="#">page 5-2</a>
		When placing originals in the document processor, place them face-up.	<a href="#">page 5-3</a>
Paper often jams.	Is the paper loaded correctly?	Load the paper correctly.	<a href="#">page 3-7</a> <a href="#">page 3-10</a>
	Is the paper of the supported type? Is it in good condition?	Remove the paper, turn it over, and reload it.	<a href="#">page 3-7</a>
	Is the paper curled, folded or wrinkled?	Replace the paper with new paper.	<a href="#">page 3-7</a>
	Are there any loose scraps or jammed paper in the machine?	Remove any jammed paper.	<a href="#">page 9-16</a>
2 or more sheets are overlaps when ejected. (multi feed) 	—	Load the paper correctly.	<a href="#">page 3-7</a> <a href="#">page 3-10</a>
Printouts are wrinkled. 	Is the paper damp?	Replace the paper with new paper.	<a href="#">page 3-5</a>

Symptom	Checkpoints	Corrective Actions	Reference Page
Printouts are curled. 	Is the paper damp?	Replace the paper with new paper.	<a href="#">page 3-5</a>
Cannot print.	Is the machine plugged in?	Plug the power cord into an AC outlet.	—
	Is the machine powered on?	Turn on the power switch.	<a href="#">page 2-8</a>
	Is the printer cable connected?	Connect the correct printer cable securely.	<a href="#">page 2-6</a>
	Is the machine used as a shared printer?	Start up the Host PC.	—
	Is the print job paused?	Resume printing.	<a href="#">page 6-7</a>
Printouts are totally too light. 	Is the paper damp?	Replace the paper with new paper.	<a href="#">page 3-5</a>
	Have you changed the density?	Select appropriate density level.	<a href="#">page 5-15</a> <a href="#">page 7-15</a>
	Is the toner distributed evenly within the toner container?	Shake the toner container from side to side several times.	<a href="#">page 9-3</a>
	Is EcoPrint mode enabled?	Disable EcoPrint mode.	<a href="#">page 5-22</a> <a href="#">page 7-13</a>
	—	Make sure the paper type setting is correct for the paper being used.	<a href="#">page 7-7</a>
Part of the image is periodically faint or shows white lines. 	—	Run [Drum Refresh].	<a href="#">page 7-15</a>
Printouts are fuzzy. 	Is the machine being used in conditions of very humid, or humidity or temperature rapidly changes?	Use in an environment that has suitable humidity.	—
Texts are not clearly printed. 	Did you choose appropriate image quality for the original?	Select appropriate image quality.	<a href="#">page 5-15</a>

Symptom	Checkpoints	Corrective Actions	Reference Page
<p>Printouts are too dark even though the background of the scanned original is white.</p> 	<p>Have you changed the density?</p>	<p>Select appropriate density level.</p>	<p><a href="#">page 5-15</a> <a href="#">page 7-15</a></p>
<p>Copies have a moire pattern (dots grouped together in patterns and not aligned uniformly).</p> 	<p>Is the original a printed photograph?</p>	<p>Set the original image to [Photo].</p>	<p><a href="#">page 5-15</a></p>
<p>Black dots appear on the white background when white original is scanned.</p> 	<p>Is the original cover or the glass platen dirty?</p>	<p>Clean the original cover or the glass platen.</p>	<p><a href="#">page 9-2</a></p>
<p>Printouts have vertical lines.</p> 	<p>Is the slit glass dirty?</p>	<p>Clean the slit glass.</p>	<p><a href="#">page 9-2</a></p>
<p>Images are skewed.</p> 	<p>Are the originals loaded correctly?</p>	<p>When placing originals on the platen, align them with the original size indicator plates.</p>	<p><a href="#">page 5-2</a></p>
	<p>Is the paper loaded correctly?</p>	<p>When placing originals in the document processor, align the original width guides securely before placing the originals.</p>	<p><a href="#">page 5-3</a></p>
		<p>Check the position of the paper width guides.</p>	<p><a href="#">page 3-7</a> <a href="#">page 3-10</a></p>

## Responding to Messages

If a problem has occurred in the machine, you will be notified by the following display.

- The [Attention] indicator on the operation panel is lit or flashing.
- An error message appears in the message display of the machine's operation panel.

If the [Attention] indicator is lit or flashing and an error message appears in the message display of the machine's operation panel, check the KYOCERA Client Tool or Status Monitor.

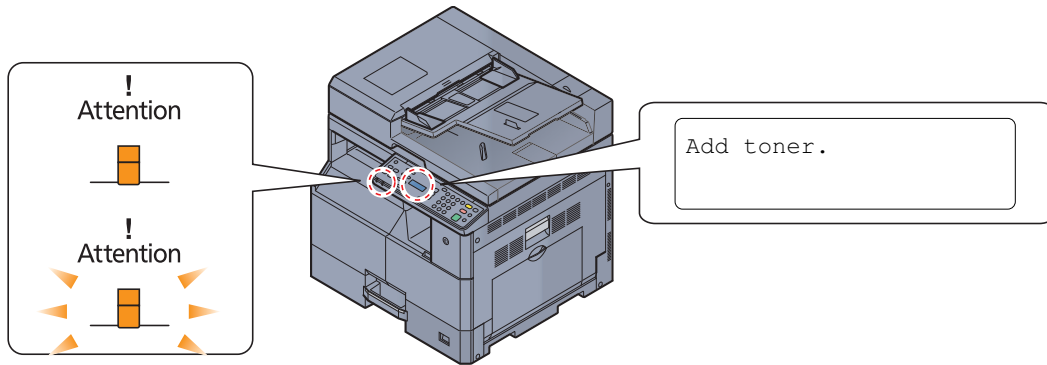

### NOTE

If the indicators light or flash repeatedly in manners not described above, a service error has probably occurred. Turn off the power, unplug the power cord, and then plug the power cord back in and turn on the power. This may clear the error. Even if the error is not cleared, contact your service representative.

Problems that can be resolved by the user are described below.

### A

Message Display	Checkpoints	Corrective Actions	Reference Page
Add toner.	Toner is empty.	Replace the toner container.	<a href="#">page 9-3</a>

### C

Message Display	Checkpoints	Corrective Actions	Reference Page
Call service.	—	An error has occurred in the machine. Make a note of the error code displayed on the message display, and contact your service representative.	—
Cannot duplex print on this paper. ↑↓ (Displayed alternately) OF II (paper size) Bond (media type) OK: Go next step	Did you select a paper size/type that cannot be duplex printed?	Press the [OK] key to move to the next step. <ul style="list-style-type: none"> <li>• Select [Select paper] to select the other paper source.</li> <li>• Select [Go without change] to print without using Duplex function.</li> </ul>	—
Clean the scanner.	—	Clean the slit glass using the cleaning cloth supplied with the document processor.	<a href="#">page 9-2</a>
Close the Document processor.	Is the document processor open?	Close the document processor.	—

Message Display	Checkpoints	Corrective Actions	Reference Page
Close the Document processor cover.	Is the top cover of the document processor open?	Close the document processor cover.	—
Close the front cover.	Is the front cover open?	Close the front cover.	—
Close the right cover #.	Is there any cover which is open?	Close the cover indicated on the screen.	—

## E

Message Display	Checkpoints	Corrective Actions	Reference Page
Error. Power off.	—	System error has occurred. Turn the power switch OFF and then ON.	—

## I

Message Display	Checkpoints	Corrective Actions	Reference Page
Incorrect account ID. Job is canceled.	—	The account ID was incorrect when processing the job externally. The job is canceled. Press the [OK] key.	—
Insufficient memory. Cannot start the job.	—	Job cannot be started. Try again later.	—

## J

Message Display	Checkpoints	Corrective Actions	Reference Page
Job Accounting restriction exceeded.	Is the acceptable printing count restricted by job accounting exceeded?	The printing count exceeded the acceptable count restricted by job accounting. Cannot print any more. This job is canceled. Press the [OK] key.	—

## L

Message Display	Checkpoints	Corrective Actions	Reference Page
Load paper in cassette #. ↑↓ (Displayed alternately) A4 (paper size) Plain (media type) OK: Go next step	Is the indicated cassette out of paper?	Load paper. Press the [OK] key to move to the next step. <ul style="list-style-type: none"> <li>Select [Select paper] to select the other paper source.</li> <li>Select [Go without change] to print on the paper in the currently selected paper source.</li> </ul>	—
	Does the selected paper size matches the paper size loaded in the specified paper source?		
Load paper in MP tray. ↑↓ (Displayed alternately) A4 (paper size) Plain (media type) OK: Go next step	Is the MP tray out of paper?	Press the [OK] key to move to the next step. <ul style="list-style-type: none"> <li>Select [Select paper] to select the other paper source.</li> <li>Select [Go without change] to print on the paper in the currently selected paper source.</li> </ul>	—
	Does the selected paper size matches the paper size loaded in the specified paper source?		

## M

Message Display	Checkpoints	Corrective Actions	Reference Page
Maximum Number of scanned pages.	Is the acceptable scanning count exceeded?	Cannot scan pages any more. The job is canceled. Press the <b>[OK]</b> key.	—
Memory is full.	—	Unable to continue the job as the memory is used up. Change the print resolution from Fast 1200 to 600 dpi. Refer to <b>Printer Driver User Guide</b> .	—

## N

Message Display	Checkpoints	Corrective Actions	Reference Page
Non-genuine Toner.	Is the installed toner container our own brand?	The manufacturer assumes no responsibility for damage caused by a non-genuine toner. We recommend that you only use genuine toner containers. When you want to use the toner container currently installed, press the <b>[OK]</b> key and the <b>[Stop]</b> key simultaneously for 3 seconds or more.	—

## P

Message Display	Checkpoints	Corrective Actions	Reference Page
PaperJam.(Cassette 1 (to 4))	—	A paper jam has occurred. Refer to <a href="#">Clearing Paper Jams on page 9-16</a> and remove the jammed paper.	<a href="#">page 9-16</a>
PaperJam (MP tray)			
PaperJam. (RightCover1) ↑↓ (Displayed alternately) Check (A1)(A2) in the Right Cover 1.			
PaperJam (RightCover2 (or 3))			
Paper Jam. (DP) ↑↓ (Displayed alternately) Check (B)(C) in the DP Cover	A paper jam has occurred in the document processor.	A paper jam has occurred. Refer to <a href="#">Clearing Paper Jams on page 9-16</a> and remove the jammed paper.	<a href="#">page 9-16</a>
Print overrun. Job is canceled.	—	Warning. Low printer memory. The job was canceled. Press the <b>[OK]</b> key.	—

## R

Message Display	Checkpoints	Corrective Actions	Reference Page
Remove originals in document processor.	Are there any originals left in the document processor?	Remove originals from the document processor.	—
Remove the paper from the inner tray.	—	Remove paper from the inner tray. Press the <b>[OK]</b> key to resume printing.	—

Message Display	Checkpoints	Corrective Actions	Reference Page
Replace all originals and press Start key.	—	Remove originals from the document processor, put them back in their original order, and place them again. Press the [OK] key to resume printing. Press the [Stop] key to cancel the job.	—
Replace MK.	—	Replacement of the parts in the maintenance kit is necessary at every 150,000 pages of printing and requires professional servicing. Contact your Service Representative.	—
Restricted by Job Accounting. (Print)	—	This job is canceled because it is restricted by job accounting. Press the [OK] key.	—
Restricted by Job Accounting. (Scan)	—	This job is canceled because it is restricted by job accounting. Press the [OK] key.	—

## S

Message Display	Checkpoints	Corrective Actions	Reference Page
Scanner memory is full.	—	Scanning cannot be performed any more due to insufficient memory of scanner. Press the [OK] key to cancel the job.	—
Set another cassette.	Have you selected Offset?	To use offsetting, the same size of paper as the selected paper source must be loaded in a different orientation in a different paper source.	<a href="#">page 5-20</a>
Shake the toner container.	—	Open the front cover of the machine and pull out the toner container. Shake the toner container well and reinstall it.	<a href="#">page 9-3</a>

## T

Message Display	Checkpoints	Corrective Actions	Reference Page
Toner is low. (Replace when empty.)	—	It is almost time to replace the toner container. Obtain a new toner container.	—

## U

Message Display	Checkpoints	Corrective Actions	Reference Page
Unknown toner installed.PC	Does the installed toner container's regional specification match the machine's?	Install the specified toner container.	<a href="#">page 9-3</a>

Message Display	Checkpoints	Corrective Actions	Reference Page
USB cable was disconnected.	Is the USB cable connected?	Press the [OK] key and connect the USB cable.	<a href="#">page 2-7</a>
	Is the PC powered on?	Press the [OK] key and turn the PC power on.	—
	Cannot find KYOCERA Client Tool.	Press the [OK] key and open KYOCERA Client Tool.	<a href="#">page 2-19</a>

## W

Message Display	Checkpoints	Corrective Actions	Reference Page
WasteTonerBox is full or not installed.	—	The waste toner box is not installed correctly. Set it correctly.	<a href="#">page 9-6</a>
	Is the waste toner box full?	Replace the waste toner box.	<a href="#">page 9-6</a>



## Clearing Paper Jams

If a paper jam occurs, [Paper Jam] appears in the message display and the machine will stop. This section explains the procedures to remove the jammed paper.

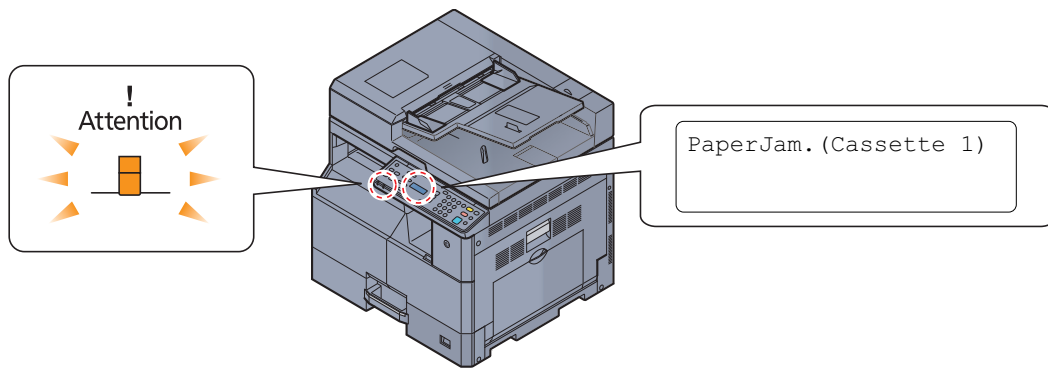

### Jam Location

Detailed paper jam positions are as follows.

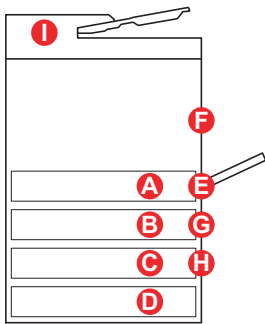

Error Message		Paper Jam Location	Reference Page
PaperJam. (Cassette 1)	<b>A</b>	Cassette 1	<a href="#">page 9-17</a>
PaperJam. (Cassette 2)	<b>B</b>	Cassettes 2 to 4	<a href="#">page 9-17</a>
PaperJam. (Cassette 3)	<b>C</b>		
PaperJam. (Cassette 4)	<b>D</b>		
PaperJam (MP tray)	<b>E</b>	Multi purpose tray	<a href="#">page 9-17</a>
PaperJam. (RightCover) ↑↓ (Displayed alternately.) Check the point. (A1) (A2)	<b>F</b>	Inside right cover 1	<a href="#">page 9-18</a>
PaperJam (RightCover2)	<b>G</b>	Inside right covers 2 or 3	<a href="#">page 9-19</a>
PaperJam (RightCover3)	<b>H</b>		
Paper Jam. (DP)	<b>I</b>	Document processor	<a href="#">page 9-19</a>

After you clear the jam, the machine will warm up again and the error message will be cleared. The machine resumes with the page that was printing when the jam occurred.

### Precautions with Paper Jams

- Do not reuse jammed papers.
- If the paper tears during removal, be sure to remove any loose scraps of paper from inside the machine. Scraps of paper left in the machine could cause subsequent jamming.
- After clearing the paper jam, close the cassette and cover in the reverse procedure.

#### CAUTION

The fixing unit is extremely hot. Take sufficient care when working in this area, as there is a danger of getting burned.

## Cassette 1

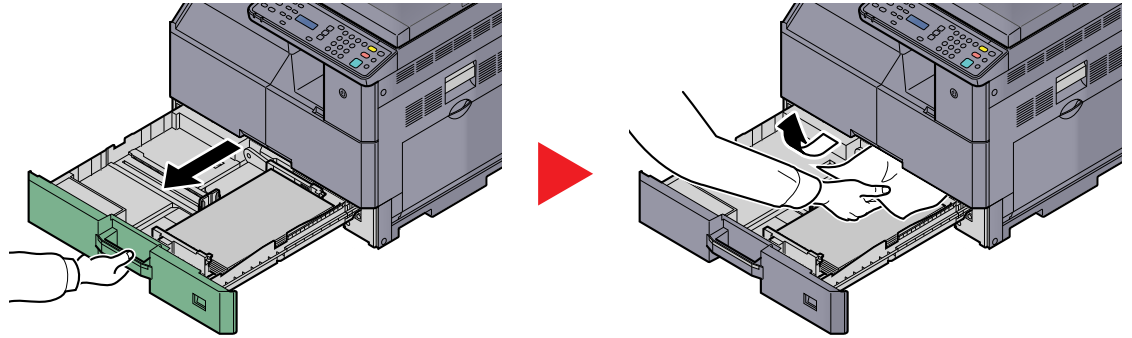

## Cassettes 2 to 4

Procedures for handling a paper jam in Cassettes 2, 3, and 4 are all the same. This section explains procedures using Cassette 2 as an example.

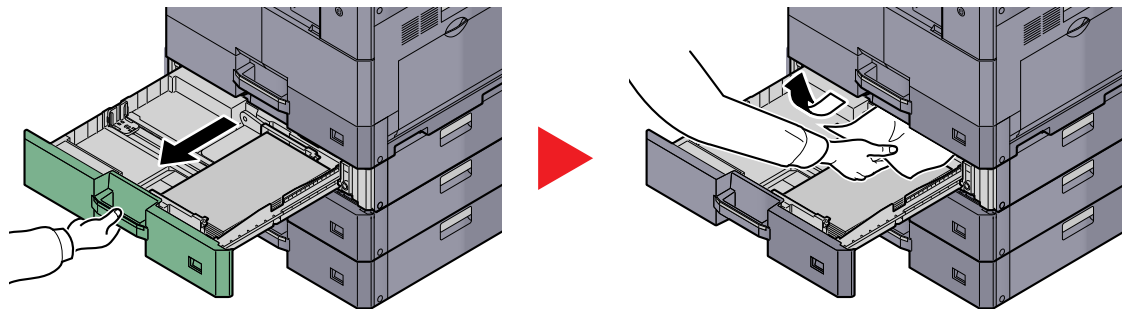

## Multi purpose tray

1

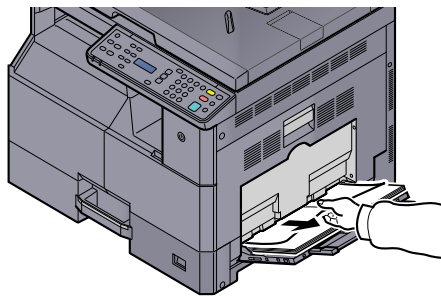

2

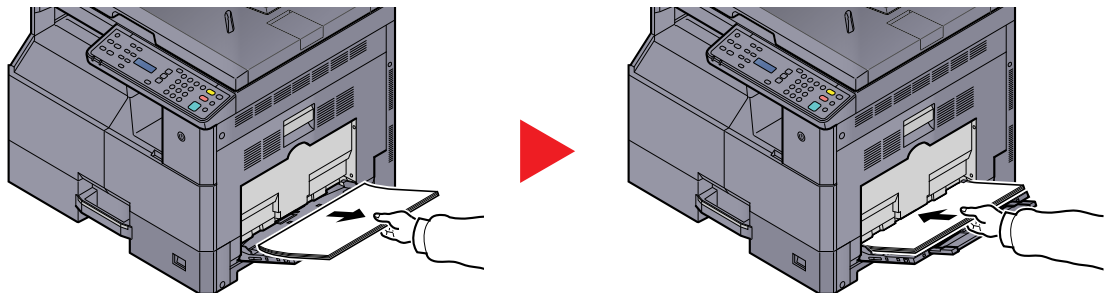

### NOTE

If you cannot remove the paper, do not forcibly pull it out. Refer to [Inside Right Cover 1 on page 9-18](#).

## Inside Right Cover 1

1

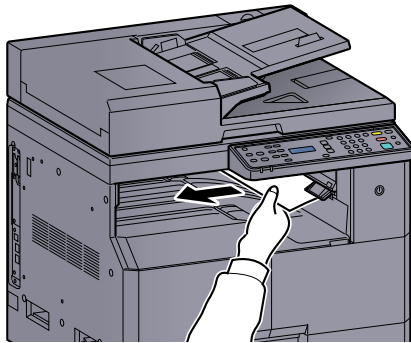

2

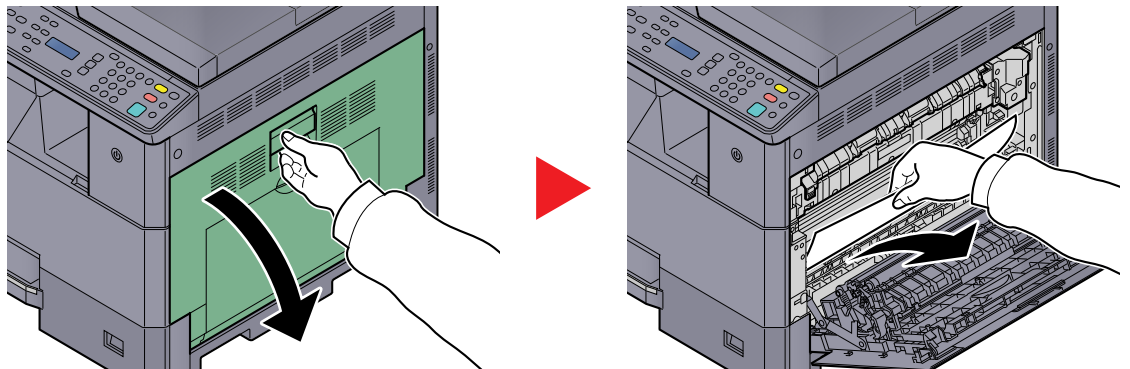

3

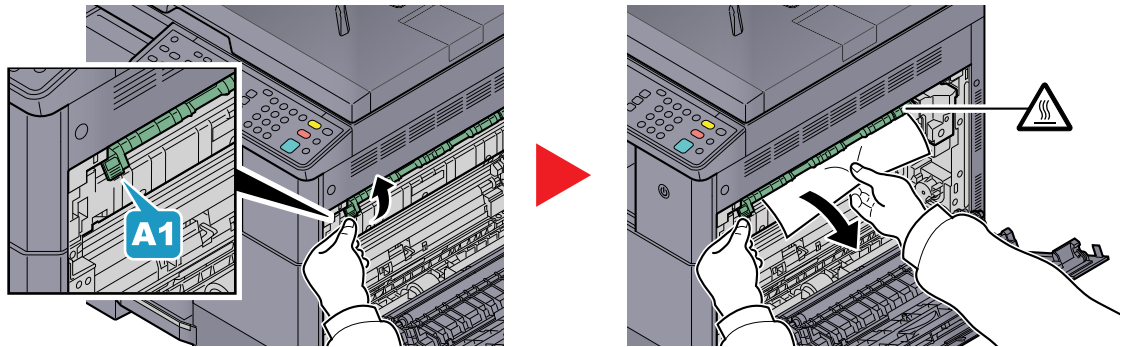

4

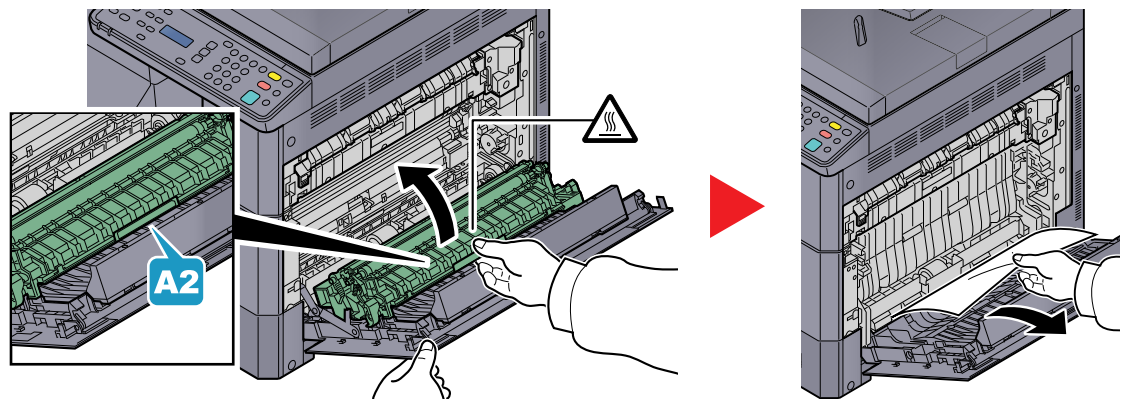

## Inside Right Covers 2 or 3

Procedures for handling a paper jam in Right Covers 2 and 3 are all the same. This section explains procedures using Right Cover 2 as an example.

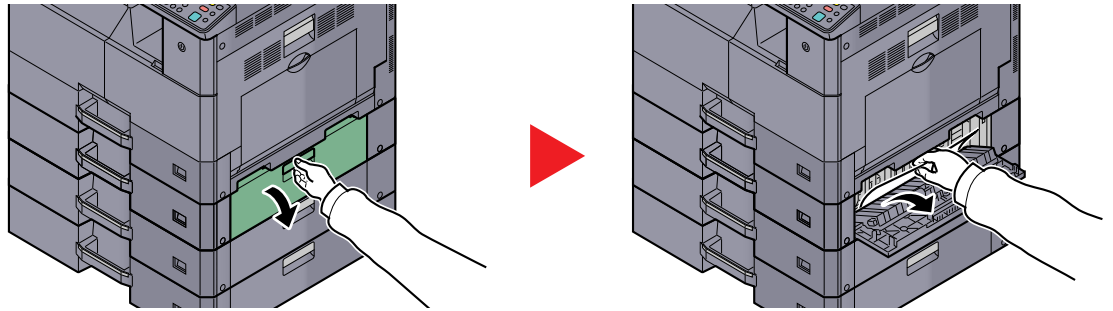

## Document Processor

1

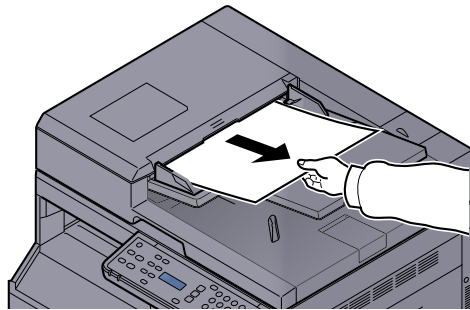

2

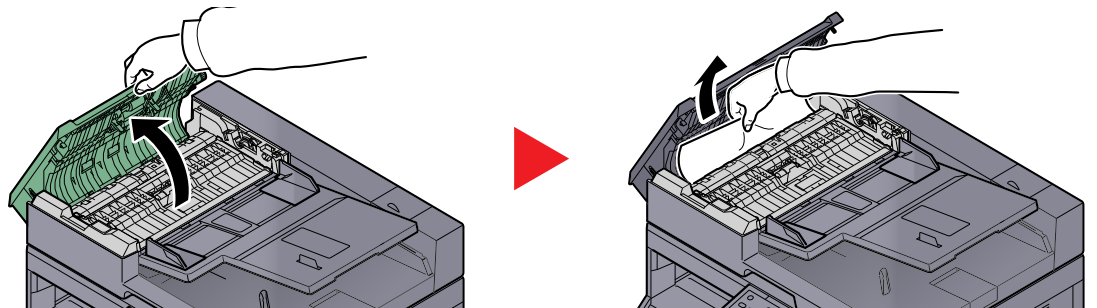

3

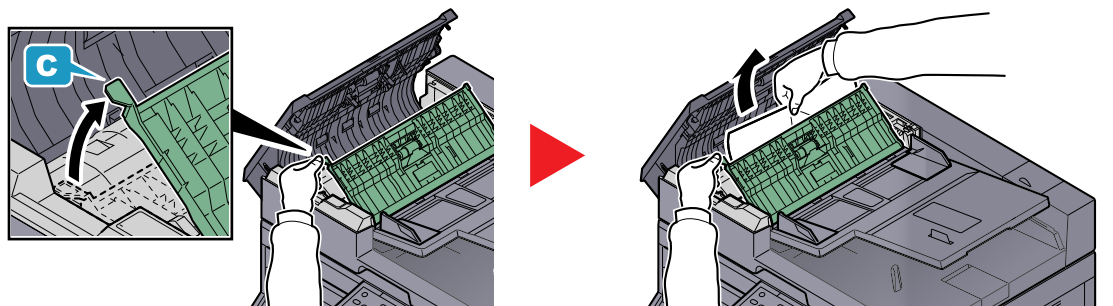

### NOTE

If the original is difficult to remove, turn the dial (B). The original will scroll out to a position where it can be removed easily.

# 10 Appendix

This chapter explains the following topics:

Optional Equipment .....	10-2
Overview of Optional Equipment .....	10-2
Character Entry Method .....	10-4
Using the Keys .....	10-4
Characters That Can be Entered Using the Numeric Keys .....	10-4
Entering Symbols .....	10-5
Entering Characters .....	10-6
Paper .....	10-7
Basic Paper Specifications .....	10-7
Choosing the Appropriate Paper .....	10-8
Special Paper .....	10-11
Specifications .....	10-15
Common Functions .....	10-15
Copy Functions .....	10-16
Printer Functions .....	10-16
Scanner Functions .....	10-17
Document Processor (Reverse Automatic) (Option) .....	10-17
Paper Feeder (300-sheet) (Option) .....	10-18
Duplex Unit (Option) .....	10-18
Glossary .....	10-19

# Optional Equipment

## Overview of Optional Equipment

The following optional equipment is available for the machine.

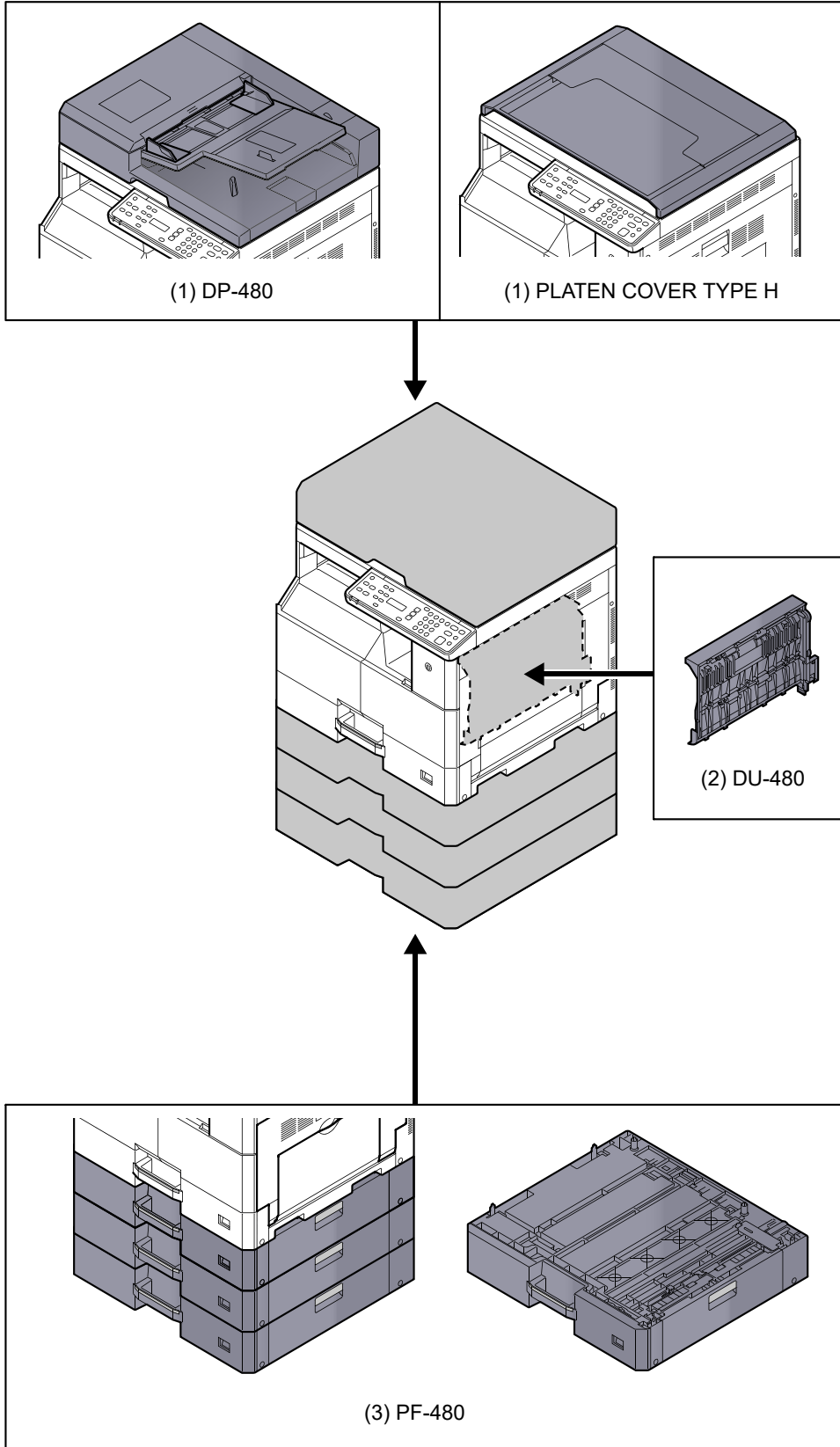

**(1) DP-480 "Document Processor (Reverse Automatic)"  
PLATEN COVER TYPE H "Original Cover" (Depends on regions, equipped  
as standard for TASKalfa 2020.)**

Automatically scans originals. Also you can perform duplex copying and split copying.

For document processor operation, refer to [Loading Originals in the Document Processor \(Option\) on page 5-3](#).

When the document processor is not used, please use the PLATEN COVER TYPE H.

**(2) DU-480 "Duplex Unit"**

Installing the duplex unit allows you to produce two-sided copies. Two-sided copies are available in sizes A3 to A5-R, Folio, Ledger to Statement-R, Executive, 216 × 340 mm (64 to 105 g/m<sup>2</sup>).

For two-sided copy settings, refer to [Duplex on page 5-15](#).

**(3) PF-480 "Paper Feeder (300-sheet)"**

Up to three additional cassettes identical to the machine's cassettes can be installed in the machine. Paper capacity and loading method are the same as the standard cassettes. Refer to [Loading in the Cassettes on page 3-7](#) for loading paper.

# Character Entry Method

This section explains how to enter characters.

## Using the Keys

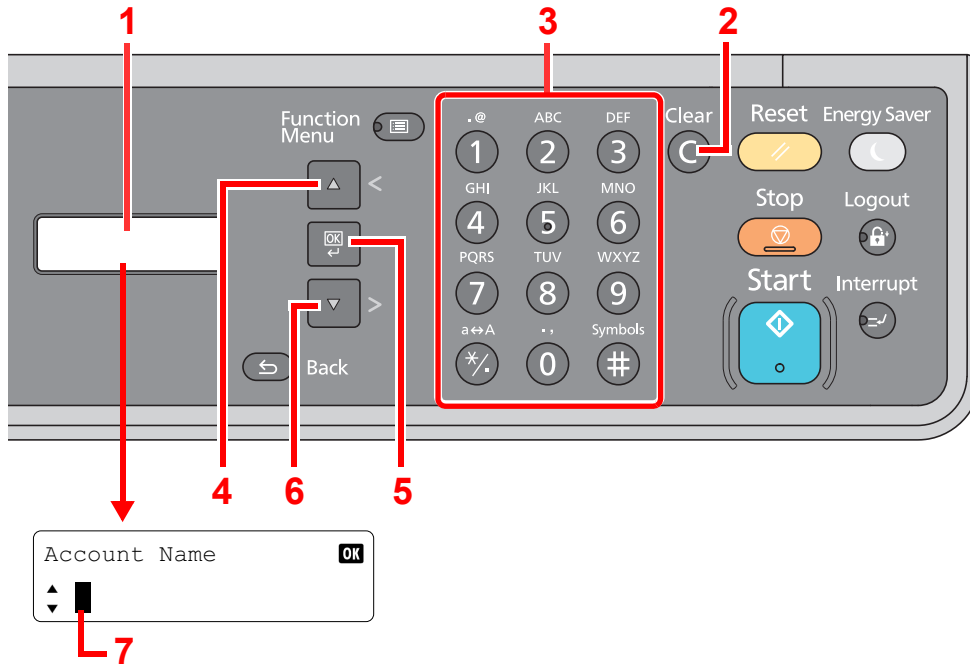

No.	Display/Key	Description
1	Message Display	Displays entered characters.
2	[Clear] key	Press to delete characters.
3	Numeric Keys	Press to enter characters and symbols.
4	[▲ (<)] key	Press to move the cursor backward.
5	[OK] key	Press to finalize entry and return to the screen before the entry. To enter a symbol, press to confirm the selected symbol.
6	[▼ (>)] key	Press to move the cursor forward.
7	Cursor	Characters are entered at the position of the cursor.

## Characters That Can be Entered Using the Numeric Keys

The following table lists the characters that can be entered using the numeric keys.

Keys	Characters (Each press of a key changes the character in the order from left to right.)
.@ 1	. @ - _ / : ~ 1 (Repeats from the first character on the left) 1 (During number entry)
ABC 2	a b c A B C 2 (Repeats from the first character on the left) 2 (During number entry)



Keys	Characters (Each press of a key changes the character in the order from left to right.)																	
DEF 3	d	e	f	D	E	F	3	(Repeats from the first character on the left)										
	3 (During number entry)																	
GHI 4	g	h	i	G	H	I	4	(Repeats from the first character on the left)										
	4 (During number entry)																	
JKL 5	j	k	l	J	K	L	5	(Repeats from the first character on the left)										
	5 (During number entry)																	
MNO 6	m	n	o	M	N	O	6	(Repeats from the first character on the left)										
	6 (During number entry)																	
PQRS 7	p	q	r	s	P	Q	R	S	7	(Repeats from the first character on the left)								
	7 (During number entry)																	
TUV 8	t	u	v	T	U	V	8	(Repeats from the first character on the left)										
	8 (During number entry)																	
WXYZ 9	w	x	y	z	W	X	Y	Z	9	(Repeats from the first character on the left)								
	9 (During number entry)																	
., 0	.	,	-	_	'	!	?	(space)	0	(Repeats from the first character on the left)								
	0 (During number entry)																	
a↔A */.	Press to change the character in the cursor position between upper case and lower case.																	
	"" or "." (During number entry)																	
Symbols #	!	"	#	\$	%	&	'	(	)	*	+	,	-	.	/	:	;	Displays the symbol list. For details, refer to <a href="#">Entering Symbols on page 10-5</a> .
	<	=	>	?	@	[	\	]	^	_	`	{		}	~			
	# (During number entry)																	
* Depending on the functions, there are symbols that cannot be entered.																		

## Entering Symbols

Symbols can be entered.

- 1 Press the [#] key. Displays the symbol list.

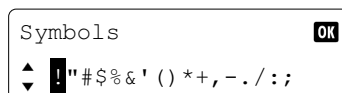

- 2 Press the [▲ (<)] or [▼ (>)] key to move the cursor and select the symbol to be entered.

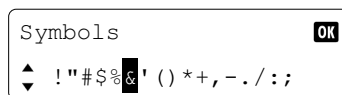

- 3 Press the [OK] key. The selected symbol is entered.

Account Name OK  
 ▲ R& █

## Entering Characters

Follow the steps shown below to enter "R&D" for example.

- 1 Press the [7] key three times. [r] is entered.

Account Name OK  
 ▲ [r] █

- 2 Press the [\*/.] key. [r] changes to [R].

Account Name OK  
 ▲ [R] █

- 3 Press the [▼ (>)] key. The cursor moves to the right.

Account Name OK  
 ▲ R █

- 4 Press the [#] key. Displays the symbol list.

Symbols OK  
 ▲ █ !"#\$%&'()\*+,-./:; █

- 5 Press the [▲ (<)] or [▼ (>)] key to move the cursor and select [&].

Symbols OK  
 ▲ !"#\$%&█'()\*+,-./:; █

- 6 Press the [OK] key. [&] is entered.

Account Name OK  
 ▲ R& █

- 7 Press the [3] key four times. [D] is entered.

Account Name OK  
 ▲ R&D █

- 8 Press the [▼ (>)] key.

Account Name OK  
 ▲ R&D █

# Paper

This section explains the paper sizes and types that can be used in the paper source.

 For details on the sizes, types, and number of sheets of paper that can be loaded in each paper tray, refer to [Specifications on page 10-15](#).

## Basic Paper Specifications

This machine is designed to print on standard copy paper as used in regular ('dry') copiers and page printers such as laser printers. It also supports a variety of other types of paper that conform to the specifications given in this appendix.

Be careful when choosing paper. Paper unsuitable for the machine may cause jams or may be wrinkled.

## Supported Paper

Use standard copy paper for regular copiers or laser printers. The printing quality will be affected by the quality of paper. Poor quality paper may result in unsatisfactory output.

## Basic Paper Specifications

The following table lists the specifications of paper that is supported with this machine. Refer to the subsequent sections for further details.

Criteria	Specifications
Weight	Cassettes: 64 to 105 g/m <sup>2</sup>
	Multi purpose tray: 45 to 160 g/m <sup>2</sup>
Dimensional accuracy	±0.7 mm
Squareness of corners	90° ±0.2°
Moisture content	4 to 6%
Pulp content	80% or more

 **NOTE**  
Some recycled paper does not meet requirements for use with this machine as listed in the Basic Paper Specifications shown below, such as moisture or pulp content. For this reason, we recommend purchasing a small amount of recycled paper as a sample for testing prior to use. Choose recycled paper that gives the best printing results and contains low levels of paper dust.

We are not responsible for the problems occurred from the use of paper that does not conform to our specifications.

## Choosing the Appropriate Paper

This section describes guidelines for choosing paper.

### Condition

Avoid using paper with bent corners or that is curled, dirty, or torn. Do not use paper that has a rough surface or paper fiber lint, or that is especially delicate. Use of paper in any of these conditions will not only deliver poor copies but may also cause jams and shorten the useful life of the machine. Choose paper with a smooth and even surface; however, avoid coated paper or paper with a treated surface as it may damage the drum or fusing unit.

### Ingredients

Do not use paper such as paper that has been coated or surface-treated or paper that contains plastic or carbon. Those types of paper may produce harmful fumes from the heat of printing and may damage the drum.

Be sure to use the standard paper that contains at least 80% pulp, i.e., not more than 20% of the total paper content consists of cotton or other fibers.

### Supported Paper Sizes

Paper of the following sizes is supported by the machine.

Measurements in the table take into account a  $\pm 0.7$  mm dimensional accuracy for length and width. Corner angles must be  $90^\circ \pm 0.2^\circ$ .

Multi Purpose Tray	Cassette or Multi Purpose Tray
A6-R (105 × 148 mm)	A3 (297 × 420 mm)
B6-R (128 × 182 mm)	B4 (257 × 364 mm)
Hagaki (100 × 148 mm)	A4 (297 × 210 mm)
Oufukuhagaki (148 × 200 mm)	A4-R (210 × 297 mm)
Executive (7 1/4 × 10 1/2")	B5 (257 × 182 mm)
Envelope DL (110 × 220 mm)	B5-R (182 × 257 mm)
Envelope C5 (162 × 229 mm)	A5-R (148 × 210 mm)
Envelope C4 (229 × 324 mm)	Folio (210 × 330 mm)
ISO B5 (176 × 250 mm)	Ledger
Envelope #10 (4 1/8 × 9 1/2")	Legal
Envelope #9 (3 7/8 × 8 7/8")	Letter
Envelope #6 3/4 (3 5/8 × 6 1/2")	Letter-R
Envelope Monarch (3 7/8 × 7 1/2")	Statement-R
Youkei 2 (114 × 162 mm)	Oficio II
Youkei 4 (105 × 235 mm)	8K (273 × 394 mm)
Size Entry (98 × 148 to 297 × 432 mm)	16K (273 × 197 mm)
	16K-R (197 × 273 mm)
	216 × 340 mm

## Smoothness

The paper surface should be smooth, but it must be uncoated. With paper that is too smooth and slippery, several sheets may accidentally be supplied at once, causing jams.

## Basis Weight

In countries that use the metric system, basis weight is the weight in grams of one sheet of paper one square meter in area. In the United States, basis weight is the weight in pounds of one ream (500 sheets) of paper cut to the standard size (or trade size) for a specific grade of paper. Paper that is too heavy or too light may be supplied incorrectly or cause paper jams, which may cause excessive wear of the machine. Mixed paper weight (i.e., thickness) may cause several sheets to be supplied at once accidentally and may also cause blurring or other printing problems if the toner fails to adhere correctly.

## Moisture Content

Paper moisture content is the ratio of moisture to dryness expressed as a percentage. Moisture affects how the paper is supplied, the electrostatic chargeability of the paper, and how the toner adheres.

Paper moisture content varies depending on the relative humidity in the room. High relative humidity causes paper to become damp, making the edges expand so it appears wavy. Low relative humidity causes paper to lose moisture, making the edges tighten and weakening print contrast.

Wavy or tight edges may cause the paper to slip when it is supplied. Try to keep the moisture content between 4 to 6%.

To maintain the right level of moisture content, bear in mind the following considerations.

- Store paper in a cool, well-ventilated place.
- Store paper flat and unopened in the package. Once the package is opened, reseal it if the paper is not to be used for a while.
- Store paper sealed in the original package and box. Put a pallet under the carton to keep it raised above the floor. Especially during rainy seasons keep the paper a sufficient distance away from wooden or concrete floors.
- Before using paper that has been stored, keep it at the proper moisture level for at least 48 hours.
- Do not store paper where it is exposed to heat, sunlight, or dampness.

## Other Paper Specifications

**Porosity:** The density of the paper fibers

**Stiffness:** Paper must be stiff enough or it may buckle in the machine, causing jams.

**Curl:** Most paper naturally tends to curl after the package is opened. When paper passes through the fixing unit, it curls upward slightly. To deliver flat printouts, load the paper so that the curl faces towards the bottom of the paper tray.

**Static electricity:** During printing, paper is electrostatically charged so that the toner adheres. Choose paper that can be discharged quickly so that copies do not cling together.

**Whiteness:** Paper whiteness affects print contrast. Use whiter paper for sharper, brighter copies.

**Quality:** Machine problems may occur if sheet sizes are not uniform or if corners are not square, edges are rough, sheets are uncut, or edges or corners are crushed. In order to prevent these problems, be especially careful when you cut the paper yourself.

**Packaging:** Choose paper that is properly packaged and stacked in boxes. Ideally, the packaging itself should have been treated with a coating to inhibit moisture.

**Specially treated paper:** We do not recommend printing onto the following types of paper, even if it conforms to the basic specifications. When you use these kinds of paper, purchase a small amount first as a sample to test.

- Glossy paper
- Watermarked paper
- Paper with an uneven surface
- Perforated paper

## Special Paper

This section describes printing onto special paper and print media.

The following paper and media can be used.

- Transparencies
- Preprinted paper
- Bond paper
- Recycled paper
- Thin paper (from 52 g/m<sup>2</sup> to 105 g/m<sup>2</sup> or less)
- Letterhead
- Colored paper
- Prepunched paper
- Envelopes
- Cardstocks (Hagaki)
- Thick paper (from 106 g/m<sup>2</sup> to 163 g/m<sup>2</sup> or less)
- Labels
- High-quality paper

When using these paper and media, choose those that are designed specifically for copiers or page printers (such as laser printers). Use the multi purpose tray for transparencies, envelopes, cardstocks, and label paper.

### Choosing Special Paper

Although special paper that meets the following requirements can be used with the machine, print quality will vary considerably due to differences in the construction and quality of special paper. Thus, special paper is more likely than regular paper to cause printing problems. Before purchasing special paper in volume, try testing a sample to ensure the print quality is satisfactory. General precautions when printing onto special paper are given below. Note that we are not responsible for any harm to the user or damage to the machine caused by moisture or specifications of special paper.

Select a cassette or multi purpose tray for special paper.

### Transparencies

Transparencies must be able to withstand the heat of printing. Transparencies must meet the following conditions.

<b>Heat resistance</b>	Must withstand at least 190°C
<b>Thickness</b>	0.100 to 0.110 mm
<b>Material</b>	Polyester
<b>Dimensional accuracy</b>	±0.7 mm
<b>Squareness of corners</b>	90° ±0.2°

To avoid problems, use the multi purpose tray for transparencies and load transparencies with the long side facing the machine.

If transparencies jam frequently at output, try pulling the leading edge of sheets gently as they are ejected.

## Label

Be sure to feed labels from the multi purpose tray.

For selecting labels, use extreme care so that the adhesive may not come in direct contact with any part of the machine and that the labels are not easily peeled from the carrier sheet. Adhesives that stick to the drum or rollers and peeled labels remaining in the machine may cause a failure.

When printing onto labels, you must be liable for the print quality and possible trouble.

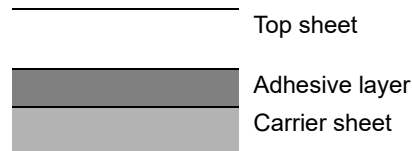

Labels consist of three layers as shown in the illustration. The adhesive layer contains materials that are easily affected by the force applied in the machine. The carrier sheet bears the top sheet until the label is used. This composition of labels may cause more problems.

The label surface must be covered completely with the top sheet. Gaps between labels may cause peeling of labels, resulting in a serious failure.

Some label paper has large margins on the top sheet. When using such paper, do not peel these margins from the carrier sheet before completing output.

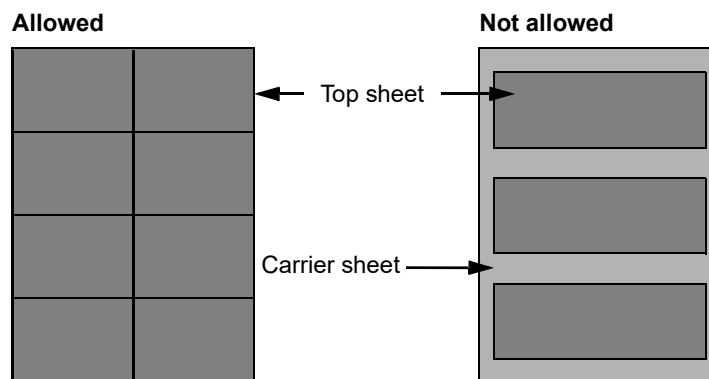

Use label paper that conforms to the following specifications.

<b>Top sheet weight</b>	44 to 74 g/m <sup>2</sup>
<b>Basis weight (overall paper weight)</b>	104 to 151 g/m <sup>2</sup>
<b>Top sheet thickness</b>	0.086 to 0.107 mm
<b>Overall paper thickness</b>	0.115 to 0.145 mm
<b>Moisture content</b>	4 to 6 % (composite)



## Hagaki

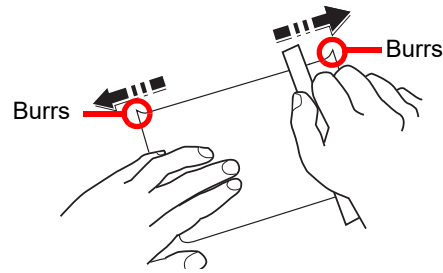

Before loading Hagaki into the multi purpose tray, fan them and align the edges. If the Hagaki paper is curled, straighten it before loading. Printing onto curled Hagaki may cause jams.

Use unfolded Oufukuhagaki (available at post offices). Some Hagaki may still have rough edges developed by a paper cutter on the back side. Remove any such rough edges by placing the Hagaki on a flat surface and rubbing the edges gently a few times with a ruler.

## Envelopes

Use the multi purpose tray for envelopes.

Due to the structure of envelopes, printing evenly over the entire surface may not be possible in some cases. Thin envelopes in particular may be wrinkled by the machine in some cases as they pass through. Before purchasing envelopes in volume, try testing a sample to ensure the print quality.

Storing envelopes for a long period may cause them to become wrinkled. Thus, keep the package sealed until you are ready to use them.

Keep the following points in mind.

- Do not use envelopes with exposed adhesive. In addition, do not use the type of envelope in which the adhesive is exposed after the top layer is peeled off. Serious damage may be caused if the paper covering the adhesive comes off in the machine.
- Do not use envelopes with certain special features. For example, do not use envelopes with a grommet for winding a string to close the flap or envelopes with an open or film-covered window.
- If paper jams occur, load fewer envelopes at once.
- To prevent paper jams when printing onto multiple envelopes, do not allow more than ten envelopes to remain in the Inner tray at once.

## Thick Paper

Before loading thick paper in the multi purpose tray, fan it and align the edges. Some thick paper may still have rough edges developed by a paper cutter on the back side. Remove any such rough edges just as with Hagaki by placing the paper on a flat surface and rubbing the edges gently a few times with a ruler. Printing onto paper with rough edges may cause jams.



### NOTE

If the paper is not supplied correctly even after it is smoothed, load the paper in the multi purpose tray with the leading edge raised a few millimeters.

## Colored Paper

Colored paper must conform to the specifications listed on [page 10-7](#). In addition, the pigments in the paper must be able to withstand the heat of printing (up to 200°C or 392°F).

## Preprinted Paper

Preprinted paper must conform to the specifications listed on [page 10-7](#). The colored ink must be able to withstand the heat of printing. It must be resistant to silicone oil as well. Do not use paper with a treated surface such as glossy paper used for calendars.

## Recycled Paper

Recycled paper must conform to the specifications listed on [page 10-7](#); however, its whiteness may be considered separately.



### NOTE

Before purchasing recycled paper in volume, try testing a sample to ensure satisfactory print quality.

# Specifications

 **IMPORTANT**

Specifications are subject to change without notice.

## Common Functions

Item		Description
<b>Type</b>		Desktop
<b>Printing Method</b>		Electrophotography by semiconductor laser, single drum system
<b>Paper Weight</b>	<b>Cassette</b>	64 to 105 g/m <sup>2</sup>
	<b>Multi Purpose Tray</b>	45 to 160 g/m <sup>2</sup> , 230 g/m <sup>2</sup> (Cardstock)
<b>Paper Type</b>	<b>Cassette</b>	Plain, Rough, Vellum, Recycled, Preprinted, Bond, Color (Colour), Prepunched, Letterhead, Thick, High Quality, Custom 1 to 8
	<b>Multi Purpose Tray</b>	Plain, Transparency (OHP film), Rough, Vellum, Labels, Recycled, Preprinted, Bond, Cardstock, Color (Colour), Prepunched, Letterhead, Envelope, Thick, High Quality, Custom 1 to 8
<b>Paper Size</b>	<b>Cassette</b>	A3, B4, A4, A4-R, B5, B5-R, A5-R, Ledger, Legal, Oficio II, Letter-R, Letter, Statement-R, Folio, 8K, 16K, 16K-R, 216 × 340 mm
	<b>Multi Purpose Tray</b>	A3, B4, A4, A4-R, B5, B5 (ISO), B5-R, A5-R, B6-R, A6-R, Oufukuhagaki, Hagaki, Envelope DL, Envelope C5, Envelope C4, Envelope #10, Envelope #9, Envelope #6 3/4, Envelope Monarch, Youkei 2, Youkei 4, Ledger, Legal, Oficio II, Letter, Letter-R, Statement-R, Executive, Folio, 216 × 340 mm, 8K, 16K, 16K-R, Size Entry (Metric: X; 148 to 432 mm (in 1 mm increments), Y; 98 to 297 mm (in 1 mm increments), Inch: X; 5.83 to 17.00" (in 0.01" increments), Y; 3.86 to 11.69" (in 0.01" increments))
<b>Warm-up Time (22°C/71.6°F, 60%)</b>	<b>Power on</b>	17.2 seconds or less
	<b>Sleep</b>	11 seconds or less
<b>Paper Capacity</b>	<b>Cassette</b>	300 sheets (80 g/m <sup>2</sup> )
	<b>Multi Purpose Tray</b>	A4/Letter or less: 100 sheets (80 g/m <sup>2</sup> ) More than A4/Letter: 25 sheets (80 g/m <sup>2</sup> )
<b>Output Tray Capacity</b>		250 sheets (80 g/m <sup>2</sup> )
<b>Image Write System</b>		Semiconductor laser and electrophotography
<b>Main Memory</b>		256 MB
<b>Interface</b>		USB Interface Connector: 1 (USB Hi-Speed)
<b>Operating Environment</b>	<b>Temperature</b>	10 to 32.5°C/50 to 90.5°F
	<b>Humidity</b>	10 to 80 %
	<b>Altitude</b>	3,500 m/11,482.8 ft maximum
	<b>Brightness</b>	1,500 lux maximum
<b>Dimension (W × D × H) (with original cover)</b>		22 1/4 × 20 3/4 × 19 1/8" 565 × 527 × 485 mm
<b>Weight (with toner container)</b>		59.5 lb/27 kg or less
<b>Space Required (W × D) (Using multi purpose tray)</b>		32 5/8 × 20 3/4" 829 × 527 mm
<b>Power Source</b>		220-240 V ~ 50/60 Hz 6.3 A

Item	Description
<b>The power consumption of the product in networked standby (If all network ports are connected.)</b>	The information is available at the website below. <a href="https://www.kyoceradocumentsolutions.eu/en/about-us/our-brand/environmental-policy.html">https://www.kyoceradocumentsolutions.eu/en/about-us/our-brand/environmental-policy.html</a>
<b>Options</b>	Refer to <a href="#">Optional Equipment on page 10-2</a> .

## Copy Functions

Item	Description
<b>Copy Speed</b>	TASKalfa 2320                      TASKalfa 2020
	<b>feed from Cassette</b>
	A4                      23 sheets/min                      20 sheets/min
	Letter                      22 sheets/min                      20 sheets/min
	A4-R/Letter-R                      13 sheets/min                      13 sheets/min
	A3/Ledger                      10 sheets/min                      10 sheets/min
	B4/Legal                      11 sheets/min                      11 sheets/min
	B5                      23 sheets/min                      20 sheets/min
	B5-R                      13 sheets/min                      13 sheets/min
	A5-R                      10 sheets/min                      10 sheets/min
	<b>feed from Multi Purpose Tray</b>
	A4                      16 sheets/min                      16 sheets/min
	Letter                      16 sheets/min                      16 sheets/min
	A4-R/Letter-R                      11 sheets/min                      11 sheets/min
	A3/Ledger                      9 sheets/min                      9 sheets/min
B4/Legal                      10 sheets/min                      10 sheets/min	
B5                      16 sheets/min                      16 sheets/min	
B5-R                      11 sheets/min                      11 sheets/min	
A5-R                      9 sheets/min                      9 sheets/min	
A6-R                      9 sheets/min                      9 sheets/min	
<b>First Copy Time (A4, feed from Cassette)</b>	5.7 seconds or less
<b>Zoom Level</b>	Manual mode: 25 to 400%, 1% increments Auto mode: Preset Zoom
<b>Continuous Copying</b>	1 to 999 sheets
<b>Resolution</b>	600 × 600 dpi
<b>Supported Original Types</b>	Sheet, Book, 3-dimensional objects (maximum original size: Ledger/A3)
<b>Original Feed System</b>	Fixed

## Printer Functions

Item	Description
<b>Printing Speed</b>	Same as Copying Speed.
<b>First Print Time (A4, feed from Cassette)</b>	5.7 seconds or less
<b>Resolution</b>	600 × 600 dpi, Fast 1200 dpi

Item	Description
<b>Operating System</b>	Windows 8.1, Windows 10, Windows Server 2012/R2, Windows Server 2016, Windows Server 2019, Mac OS 10.5 or later
<b>Interface</b>	USB Interface Connector: 1 (USB Hi-Speed)
<b>Page Description Language</b>	Hostbased (GDI)

## Scanner Functions

Item	Description
<b>Resolution</b>	B/W: 600 dpi, 400 dpi, 300 dpi, 200 dpi Color, Grayscale: 300 dpi, 200 dpi
<b>File Format</b>	TIFF (MMR/JPEG compression), PDF (MMR/JPEG compression/ high compression), JPEG, BMP, PNG
<b>Scanning Speed</b>	<600 dpi> 1-sided B/W 22 Images/min 2-sided B/W 8 Images/min <300dpi> 1-sided B/W 22 Images/min Grayscale 14 Images/min Color 14 Images/min 2-sided B/W 8 Images/min Grayscale 6 Images/min Color 6 Images/min (A4 landscape, Image quality: Text/Photo original)
<b>Interface</b>	USB

## Document Processor (Reverse Automatic) (Option)

Item	Description
<b>Original Feed Method</b>	Automatic feed
<b>Supported Original Types</b>	Sheet originals
<b>Paper Size</b>	Maximum: Ledger/A3 Minimum: Statement-R/A5-R
<b>Paper Weight</b>	1-sided: 45 to 120 g/m <sup>2</sup> 2-sided: 50 to 120 g/m <sup>2</sup>
<b>Loading Capacity</b>	50 sheets (50 to 80 g/m <sup>2</sup> ) maximum When originals have different widths: 30 sheets (50 to 80 g/m <sup>2</sup> ) maximum
<b>Dimensions (W) × (D) × (H)</b>	22 3/16 × 17 1/4 × 5" 563 × 439 × 128 mm
<b>Weight</b>	13.2 lbs. or less / 6 kg or less

## Paper Feeder (300-sheet) (Option)

Item	Description
<b>Paper Supply Method</b>	Automatic Feeding (No. Sheets: 300, 80 g/m <sup>2</sup> )
<b>Paper Size</b>	A3, B4, A4, A4-R, B5, B5-R, A5-R, Ledger, Legal, Oficio II, Letter-R, Letter, Statement-R, Folio, 8K, 16K, 16K-R, 216 × 340 mm
<b>Supported Paper</b>	Paper weight: 64 to 105 g/m <sup>2</sup> Media types: Plain, Rough, Vellum, Recycled, Preprinted, Bond, Color (Colour), Prepunched, Letterhead, Thick, High Quality, Custom 1 to 8
<b>Dimensions (W) × (D) × (H)</b>	22 1/4 × 20 1/2 × 5 7/8" 565 × 520 × 148.5 mm
<b>Weight</b>	13.2 lbs. / 6 kg

## Duplex Unit (Option)

Item	Description
<b>Paper Size</b>	A3, B4, A4, A4-R, B5, B5-R, A5-R, Ledger, Legal, Oficio II, Letter-R, Letter, Statement-R, Executive, Folio, 216 × 340 mm
<b>Supported Paper</b>	Paper weight: 64 to 105 g/m <sup>2</sup> Media types: Plain, Rough, Recycled, Preprinted, Bond, Color (Colour), Prepunched, Letterhead, Thick, High Quality, Custom 1 to 8
<b>Dimensions (W) × (D) × (H)</b>	14 3/4 × 2 3/8 × 8 5/8" 375 × 60 × 220 mm
<b>Weight</b>	Approx. 2.2 lbs. / Approx. 1 kg



### NOTE

Consult your dealer or service representative for recommended paper types.

# Glossary

## Auto Form Feed Timeout

During data transmission, the machine may sometimes have to wait until receiving the next data. This is the auto form feed timeout. When the preset timeout passes, the machine automatically prints output. However, no output is performed if the last page has no data to be printed.

## Auto Paper Selection

A function to automatically select paper in the same size as originals when printing

## dpi (dots per inch)

A unit for resolution, representing the number of dots printed per inch (25.4 mm).

## EcoPrint Mode

A printing mode that helps save toner. Copies made in this mode are thus lighter than normal.

## Grayscale

A computer color expression. Displayed images of this sort are typically composed of shades of gray, varying from black at the weakest intensity to white at the strongest, without any other colors. Gray levels are displayed in numerical levels: that is, white and black only for 1 bit; 256 gray levels (including white and black) for 8 bits; and 65,536 gray levels for 16 bits.

## Multi Purpose (MP) Tray

The paper supply tray on the right side of the machine. Use this tray instead of the cassettes when printing onto envelopes, Hagaki, transparencies, or labels.

## PDF/A

This is "ISO 19005-1. Document management - Electronic document file format for long-term preservation - Part 1: Use of PDF (PDF/A)", and is a file format based on PDF 1.4. It has been standardized as ISO 19005-1, and is a specialization of PDF, which has been mainly used for printing, for long-term storage. A new part, ISO 19005-2 (PDF/A-2), is currently being prepared.

## PPM (prints per minute)

This indicates the number of A4 size printouts made in one minute.

## Printer Driver

The software to enable you to print data created on any application software. The printer driver for the machine is contained in the Product Library disk enclosed in the package. Install the printer driver on the computer connected to the machine.

## Sleep Timer

A mode designed for electrical power saving, activated when the machine is left unused or there is no data transfer for a specific period. In Sleep mode, power consumption is kept to a minimum.

## **Status Page**

The page lists machine conditions, such as the memory capacity, total number of prints and scans, and paper source settings.

## **TWAIN (Technology Without An Interesting Name)**

A technical specification for connecting scanners, digital cameras, and other image equipment to computers. The TWAIN compatible devices enable you to process image data on any relevant application software. TWAIN is adopted on a large amount of graphic software (e.g. Adobe Photoshop) and OCR software.

## **USB (Universal Serial Bus) 2.0**

A USB interface standard for Hi-Speed USB 2.0. The maximum transfer rate is 480 Mbps. This machine is equipped with USB 2.0 for high-speed data transfer.

## **WIA (Windows Imaging Acquisition)**

A function to import images supported after Windows Me/XP from digital cameras and other peripheral devices. This function replaces what TWAIN used to do. The feature is provided as a part of Windows functions and improves ease of operation, so that you import images directly to My Computer without using any application.



# Index

## Numerics

- 2 in 1 Layout 5-19
  - Default 7-14
- 4 in 1 Layout 5-19
  - Default 7-14

## A

- Adjustment/Maintenance 7-15
- Admin/Accounting
  - Administrator Setting 2-21
  - Job Accounting 8-1
  - Unknown ID Job 8-11
- Administrator Setting 2-21
- Auto % Priority 7-14
- Auto Detect Original Size 7-7
- Auto Error Clear 7-12
- Auto Form Feed Timeout 10-19
- Auto Panel Reset 7-12
- Auto Paper Selection 7-14, 10-19
- Auto Rotation 5-25
  - Default 7-13
- Automatic 2-Sided Copy Function 1-7

## B

- Background Density 5-22, 7-15
  - Default 7-13
- Book Original Binding 5-17
  - Default 7-14
- Border Erase 5-24
  - Default 7-13
- Border Line 5-18
  - Default 7-14
- Buzzer 7-6

## C

- Canceling Jobs 6-8
  - Copy 5-30
  - Printer 4-6
  - Scan 5-37
- Cassette
  - Loading Paper 3-7
  - Paper Size and Media Type 3-13
- Cassette 1 2-2
  - Paper Jams 9-17
- Cassette 1 (to 4) Settings 7-7, 7-9
  - Cassette 1 (to 4) Size 7-9
  - Cassette 1 (to 4) Type 7-9
- Cassette 1 (to 4) Size 7-9
- Cassette 1 (to 4) Type 7-9
- Cassette Settings 3-13
- Cassettes 2 to 4 2-5
  - Paper Jams 9-17
- Character Entry Method 10-4
- Checking the Counter 2-27
- Checking the Remaining Amount of Toner 6-10

- Cleaning
  - Original Cover/Glass Platen 9-2
  - Slit Glass 9-2
- Cleaning Cloth Compartment 2-3
- Collate/Offset 5-20
  - Default 7-13
- Colored Paper 10-13
- Combine 5-18
- Common Settings 7-5
  - Default Screen 7-6
  - Display Brightness 7-6
  - Error Handling 7-11
  - Function Default 7-13
  - Language 7-5
  - Measurement 7-11
  - Original/Paper Settings 7-7
  - Preset Limit 7-11
  - Quiet Mode 7-6
  - Sound 7-6
  - Timer Settings 7-12
- Configuration 7-19
- Connecting
  - Power Cable 2-7
  - USB Cable 2-7
- Connection Method 2-6
- Continuous Scan 5-25
  - Default 7-13
- Conventions Used in This Guide xii
- Copy 5-6
- Copy Speed 10-16
- Copying Settings 7-14
  - Auto % Priority 7-14
  - Auto Paper Selection 7-14
  - Paper Selection 7-14
- Correcting Black Line 7-15
- Counting the Number of Pages Printed
  - Counter 2-27
  - Each Job Accounting 8-13
  - Print Accounting Report 8-14
  - Total Job Accounting 8-13
  - Unknown ID Job 8-11
- Custom Original Size 7-7
- Custom Paper Size 7-7

## D

- Default Paper Source 7-8
- Default Screen 7-6
- Defaults 7-13
- Density 5-15
- Density Adjustment 7-15
- Device 6-9
- Display Brightness 7-6
- Document Processor 2-2, 2-5, 10-3
  - How to Load Originals 5-3
  - Loading Originals 5-3
  - Originals Not Supported by the Document Processor 5-3
  - Originals Supported by the Document Processor 5-3
- Part Names 2-2

dpi 10-19  
Drum Refresh 7-15  
Duplex 5-15  
Duplex Paper Error 7-11  
Duplex Unit 2-5, 10-3

## E

EcoPrint 5-22, 10-19  
    Default 7-13  
Energy Saving Control Function 1-7  
Entry  
    File Name 5-25  
Envelopes 10-13  
Environment 1-3  
Error Clear Timer 7-12  
Error Handling 7-11  
    Duplex Paper Error 7-11  
    Paper Mismatch Error 7-11

## F

File Name Entry 5-25  
    Default 7-13  
Finishing Binding 5-17  
    Default 7-14  
First Copy Time 10-16  
First Print Time 10-16  
Form Feed Timeout 7-15  
Front Cover 2-2

## G

Glossary 10-19  
Grayscale 10-19  
Guides Provided with the Machine x

## H

Hagaki 10-13  
Handles 2-2

## I

ID Card Copy 5-8  
Inner Tray 2-2  
Install  
    Mac 2-18  
    Software 2-10  
    Windows 2-11  
Interface Block Setting 7-5  
Interrupt Clear 7-12  
Interrupt Copy 5-7

## J

Job  
    Available Status 6-2  
    Canceling 6-8  
    Checking History 6-4  
    Checking Status 6-2  
    Displaying History Screen 6-4  
    Displaying Status Screens 6-2  
    Pause and Resumption 6-7

## Job Accounting

Adding an Account 8-4  
Copy/Print Count 8-12  
Counting the Number of Pages Printed 8-13  
Default Setting 8-12  
Deleting an Account 8-8  
Editing an Account 8-7  
Enabling Job Accounting 8-3  
Job Accounting when Sharing the Printer 8-9  
Login 8-15  
Logout 8-15  
Overview of Job Accounting 8-2  
Print Accounting Report 8-14  
Printing When Sharing the Printer 8-15  
Restricting the Use of the Machine 8-6  
Unknown ID Job 8-11

## K

KYOCERA Client Tool 7-16  
    Accessing KYOCERA Client Tool 2-19

## L

Label 10-12  
Language 7-5  
Legal Information 1-6  
Legal Restriction on Copying 1-5  
Legal Restriction on Scanning 1-5  
Loading Originals  
    Loading Originals in the Document Processor 5-3  
    Placing Originals on the Platen 5-2  
Login Password 2-21  
Login User Name 2-21

## M

Margin 5-23  
    Default 7-13  
Measurement 7-11  
Media for Auto 7-8  
Media Type Settings 7-7, 7-10  
Mixed Size Originals 5-22  
MP Tray Settings 7-7, 7-9  
    MP Tray Size 7-9  
    MP Tray Type 7-9  
MP Tray Size 7-9  
MP Tray Type 7-9  
Multi Purpose Tray 2-3, 10-19  
    Loading Paper 3-10  
    Paper Size and Media Type 3-15

## O

Operation Panel 2-2, 3-2  
Option  
    Document Processor 10-3  
    Duplex Unit 10-3  
    Original Cover 10-3  
    Overview 10-2  
    Paper Feeder (300-sheet) 10-3

- Original
    - Auto Detect Original Size [7-7](#)
    - Custom [7-7](#)
    - Settings [7-7](#)
    - Size [xiv](#)
  - Original Binding [5-17](#)
    - Default [7-14](#)
  - Original Cover [2-5, 10-3](#)
  - Original Eject Table [2-2](#)
  - Original Image [5-15](#)
    - Default [7-13](#)
  - Original Orientation [5-21](#)
    - Default [7-13](#)
  - Original Size [5-20](#)
  - Original Size Indicator Plates [2-2](#)
  - Original Stopper [2-3](#)
  - Original Table [2-2](#)
  - Original Width Guides [2-2](#)
  - Original/Paper Settings
    - Auto Detect Original Size [7-7](#)
    - Cassette 1 (to 4) Settings [7-7](#)
    - Custom Original Size [7-7](#)
    - Custom Paper Size [7-7](#)
    - Default Paper Source [7-8](#)
    - Media for Auto [7-8](#)
    - Media Type Settings [7-7](#)
    - MP Tray Settings [7-7](#)
    - Special Paper Action [7-8](#)
- P**
- Panel Reset Timer [7-12](#)
  - Paper
    - Appropriate Paper [10-8](#)
    - Before Loading [3-6](#)
    - Cassette [7-9](#)
    - Checking the Remaining Amount of Paper [6-10](#)
    - Custom Paper Size [7-7](#)
    - Default Paper Source [7-8](#)
    - Loading Envelopes [3-12](#)
    - Loading Paper [3-5](#)
    - Loading Paper in the Cassettes [3-7](#)
    - Loading Paper in the Multi Purpose Tray [3-10](#)
    - Media Type Settings [7-10](#)
    - MP Tray [7-9](#)
    - Size and Media Type [3-13, 7-7, 10-7](#)
    - Special Paper [10-11](#)
    - Special Paper Action [7-8](#)
    - Specifications [10-7](#)
    - Weight [7-10](#)
  - Paper Feeder (300-sheet) [10-3](#)
  - Paper Jams [9-16](#)
    - Cassette 1 [9-17](#)
    - Cassettes 2 to 4 [9-17](#)
    - Document Processor [9-19](#)
    - Inside Right Cover 1 [9-18](#)
    - Inside Right Covers 2 or 3 [9-19](#)
    - Jam Location [9-16](#)
    - Multi Purpose Tray [9-17](#)
  - Paper Length Guide [2-3, 3-8](#)
  - Paper Mismatch Error [7-11](#)
  - Paper Selection [5-13, 7-14](#)
  - Paper Width Adjusting Tab [2-3, 3-8](#)
  - Paper Width Guide [2-3, 3-8](#)
  - Part Names [2-2](#)
  - PDF/A [10-19](#)
  - Platen [2-2](#)
  - Power Cable
    - Connecting [2-7](#)
  - Power Management [1-7](#)
  - Power Off [2-9](#)
  - Power Off Mode [1-7](#)
  - Power Off Rule [2-24, 7-12](#)
  - Power Off Timer [2-24, 2-25, 7-12](#)
  - Power On [2-8](#)
  - Power Switch [2-2](#)
  - PPM [10-19](#)
  - Precautions for Use [1-3](#)
  - Preparing Cables [2-6](#)
  - Preprinted Paper [10-14](#)
  - Preset Limit [7-11](#)
  - Print Box [4-8](#)
    - Printing Document from Print Box [4-10](#)
    - Saving Document to a Print Box [4-9](#)
    - Settings [7-26](#)
  - Print Density [7-15](#)
  - Print Settings [4-5](#)
  - Printer [7-15](#)
    - Form Feed Timeout [7-15](#)
  - Printer Driver [10-19](#)
    - Help [4-6](#)
  - Printing
    - Print Settings [4-5](#)
    - Printing from PC [4-2](#)
  - Printing from PC [4-2](#)
  - Printing Speed [10-16](#)
  - Product Library [x](#)
  - Program [5-26](#)
    - Changing the Program Name [5-28](#)
    - Confirming [5-27](#)
    - Deleting [5-28](#)
    - Overwriting [5-28](#)
    - Recalling [5-27](#)
    - Registering [5-26](#)
- Q**
- Quick Scan [5-35](#)
    - Settings [7-23](#)
  - Quiet Mode [7-6](#)
- R**
- Recycled Paper [10-14](#)
  - Regarding Trade Names [1-6](#)
  - Regular Maintenance [9-2](#)
    - Cleaning [9-2](#)
    - Toner Container Replacement [9-3](#)
    - Waste Toner Box Replacement [9-6](#)
  - Report
    - Accounting Report [8-14](#)
    - Report Print [7-4](#)

---

Report Print  
  Menu Map 7-4  
  Service Status 7-4  
  Status Page 7-4  
Resolution 10-16, 10-17  
Resource Saving - Paper 1-7  
Responding to Messages 9-11  
Right Cover 1 2-3  
Right Cover 1 Lever 2-3  
Right Covers 2 to 4 2-5

## S

Safety Conventions in This Guide 1-2  
Scan Color 7-20, 7-23  
Scan Destination Settings 7-20  
Scan Resolution 7-21, 7-23  
Scanning 5-31  
  Scan the Image by Selecting the Destination (Quick Scan) 5-35  
  Scan the Image to the Specified Destination 5-33  
  TWAIN 5-36  
Serial Number 5-5  
Service Settings 7-15  
  Drum Refresh 7-15  
Setting the Shared Printer 2-17  
Sleep 1-7, 2-23  
Sleep Timer 2-23, 7-12, 10-19  
Slit Glass 2-2  
Solving Malfunctions 9-8  
Sound 7-6  
  Buzzer 7-6  
Special Paper Action 7-8  
Specifications 10-15  
  Common Functions 10-15  
  Copy Functions 10-16  
  Document Processor 10-17  
  Duplex Unit 10-18  
  Paper Feeder (300-sheet) 10-18  
  Printer Functions 10-16  
  Scanner Functions 10-17  
Status 6-1  
  KYOCERA Client Tool 6-11  
  Paper Status 6-10  
  Print Job Log 6-4  
  Print Job Status 6-2  
  Printer 6-9  
  Scanner 6-9  
  Send Job Log 6-4  
  Toner Status 6-10  
Status Page 10-20  
Supplies  
  Checking the Remaining Amount 6-10  
Support Tray Section of the Multi Purpose Tray 2-3  
Symbols 1-2  
System 7-5  
  Interface Block Setting 7-5  
System Menu 7-2

## T

Thick Paper 10-13

Timer Settings 7-12  
  Auto Error Clear 7-12  
  Auto Panel Reset 7-12  
  Error Clear Timer 7-12  
  Interrupt Clear 7-12  
  Panel Reset Timer 7-12  
  Power Off Rule 7-12  
  Power Off Timer 7-12  
  Sleep Timer 7-12  
Toner Container 2-4  
Toner Container Lever 2-4  
Toner Container Replacement 9-3  
Transparencies 10-11  
TWAIN 10-20  
  Scanning using TWAIN 5-36  
  Settings 7-23

## U

Unknown ID Job 8-11  
USB 10-20  
USB Cable 2-6  
  Connecting 2-7  
USB Interface 2-6  
USB Interface Connector 2-4

## W

Waste Toner Box 2-4  
Waste Toner Box Replacement 9-6  
WIA 10-20  
  Setting WIA Driver 2-20

## Z

Zoom 5-14  
  Default 7-13

**QUALITY  
CERTIFICATE**

This machine has passed  
all quality controls and  
final inspection

**KYOCERA Document Solutions America, Inc.****Headquarters**

225 Sand Road,  
Fairfield, New Jersey 07004-0008, USA  
Phone: +1-973-808-8444  
Fax: +1-973-882-6000

**Latin America**

8240 NW 52nd Terrace, Suite 301  
Miami, Florida 33166, USA  
Phone: +1-305-421-6640  
Fax: +1-305-421-6666

**KYOCERA Document Solutions Canada, Ltd.**

6120 Kestrel Rd., Mississauga, ON L5T 1S8,  
Canada  
Phone: +1-905-670-4425  
Fax: +1-905-670-8116

**KYOCERA Document Solutions****Mexico, S.A. de C.V.**

Calle Arquimedes No. 130, 4 Piso, Colonia Polanco  
Chapultepec, Delegacion Miguel Hidalgo,  
Ciudad de Mexico, C.P. 11560  
Phone: +52-555-383-2741  
Fax: +52-555-383-7804

**KYOCERA Document Solutions Brazil, Ltda.**

Alameda África, 545, Pólo Empresarial Consbrás,  
Tamboré, Santana de Parnaíba, State of São Paulo, CEP  
06543-306, Brazil  
Phone: +55-11-2424-5353  
Fax: +55-11-2424-5304

**KYOCERA Document Solutions Chile SpA**

Jose Ananias 505, Macul. Santiago, Chile  
Phone: +56-2-2670-1900  
Fax: +56-2-2350-7150

**KYOCERA Document Solutions****Australia Pty. Ltd.**

Level 3, 6-10 Talavera Road North Ryde N.S.W, 2113,  
Australia  
Phone: +61-2-9888-9999  
Fax: +61-2-9888-9588

**KYOCERA Document Solutions****New Zealand Ltd.**

Ground Floor, 19 Byron Avenue, Takapuna, Auckland,  
New Zealand  
Phone: +64-9-415-4517  
Fax: +64-9-415-4597

**KYOCERA Document Solutions Asia Limited**

13/F., Mita Centre, 552-566, Castle Peak Road Tsuen Wan,  
New Territories, Hong Kong  
Phone: +852-2496-5678  
Fax: +852-2610-2063

**KYOCERA Document Solutions****(China) Corporation**

8F, No. 288 Nanjing Road West, Huangpu District,  
Shanghai, 200003, China  
Phone: +86-21-5301-1777  
Fax: +86-21-5302-8300

**KYOCERA Document Solutions****(Thailand) Corp., Ltd.**

335 Ratchadapisek Road, Wongsawang, Bangsue,  
Bangkok 10800,  
Thailand  
Phone: +66-2-586-0333  
Fax: +66-2-586-0278

**KYOCERA Document Solutions****Singapore Pte. Ltd.**

12 Tai Seng Street #04-01A,  
Luxasia Building, Singapore 534118  
Phone: +65-6741-8733  
Fax: +65-6748-3788

**KYOCERA Document Solutions****Hong Kong Limited**

16/F., Mita Centre, 552-566, Castle Peak Road Tsuen Wan,  
New Territories, Hong Kong  
Phone: +852-3582-4000  
Fax: +852-3185-1399

**KYOCERA Document Solutions****Taiwan Corporation**

6F., No.37, Sec. 3, Minquan E. Rd.,  
Zhongshan Dist., Taipei 104, Taiwan R.O.C.  
Phone: +886-2-2507-6709  
Fax: +886-2-2507-8432

**KYOCERA Document Solutions Korea Co., Ltd.**

#10F Daewoo Foundation Bldg 18, Toegye-ro, Jung-gu,  
Seoul, Korea  
Phone: +822-6933-4050  
Fax: +822-747-0084

**KYOCERA Document Solutions****India Private Limited**

Second Floor, Centrum Plaza, Golf Course Road,  
Sector-53, Gurgaon, Haryana 122002, India  
Phone: +91-0124-4671000  
Fax: +91-0124-4671001

**KYOCERA Document Solutions Europe B.V.**

Bloemlaan 4, 2132 NP Hoofddorp,  
The Netherlands  
Phone: +31(0)20-654-0000  
Fax: +31(0)20-653-1256

**KYOCERA Document Solutions Nederland B.V.**

Beechavenue 25, 1119 RA Schiphol-Rijk,  
The Netherlands  
Phone: +31-20-5877200  
Fax: +31-20-5877260

**KYOCERA Document Solutions (U.K.) Limited**

Eldon Court, 75-77 London Road,  
Reading, Berkshire RG1 5BS,  
United Kingdom  
Phone: +44-118-931-1500  
Fax: +44-118-931-1108

**KYOCERA Document Solutions Italia S.p.A.**

Via Monfalcone 15, 20132, Milano, Italy,  
Phone: +39-02-921791  
Fax: +39-02-92179-600

**KYOCERA Document Solutions Belgium N.V.**

Sint-Martinusweg 199-201 1930 Zaventem,  
Belgium  
Phone: +32-2-7209270  
Fax: +32-2-7208748

**KYOCERA Document Solutions France S.A.S.**

Espace Technologique de St Aubin  
Route de l'Orme 91195 Gif-sur-Yvette CEDEX,  
France  
Phone: +33-1-69852600  
Fax: +33-1-69853409

**KYOCERA Document Solutions Espana, S.A.**

Edificio Kyocera, Avda. de Manacor No.2,  
28290 Las Matas (Madrid), Spain  
Phone: +34-91-6318392  
Fax: +34-91-6318219

**KYOCERA Document Solutions Finland Oy**

Atomitie 5C, 00370 Helsinki,  
Finland  
Phone: +358-9-47805200  
Fax: +358-9-47805212

**KYOCERA Document Solutions****Europe B.V., Amsterdam (NL) Zürich Branch**

Hohlstrasse 614, 8048 Zürich,  
Switzerland  
Phone: +41-44-9084949  
Fax: +41-44-9084950

**KYOCERA Bilgitas Document Solutions  
Turkey A.S.**

Altunizade Mah. Prof. Fahrettin Kerim Gökay Cad. No:45  
34662 ÜSKÜDAR İSTANBUL, TURKEY  
Phone: +90-216-339-0020  
Fax: +90-216-339-0070

**KYOCERA Document Solutions  
Deutschland GmbH**

Otto-Hahn-Strasse 12, 40670 Meerbusch,  
Germany  
Phone: +49-2159-9180  
Fax: +49-2159-918100

**KYOCERA Document Solutions Austria GmbH**

Wienerbergstraße 11, Turm A, 18. OG, 1100 Wien,  
Austria  
Phone: +43-1-863380  
Fax: +43-1-86338-400

**KYOCERA Document Solutions Nordic AB**

Borgarfjordsgatan 11, 164 40 Kista, Sweden  
Phone: +46-8-546-550-00  
Fax: +46-8-546-550-10

**KYOCERA Document Solutions Norge Nuf**

Olaf Helsetsv. 6, 0619 Oslo, Norway  
Phone: +47-22-62-73-00  
Fax: +47-22-62-72-00

**KYOCERA Document Solutions Danmark A/S**

Ejby Industrivej 60, DK-2600 Glostrup,  
Denmark  
Phone: +45-70223880  
Fax: +45-45765850

**KYOCERA Document Solutions Portugal Lda.**

Rua do Centro Cultural, 41 (Alvalade) 1700-106 Lisboa,  
Portugal  
Phone: +351-21-843-6780  
Fax: +351-21-849-3312

**KYOCERA Document Solutions****South Africa (Pty) Ltd.**

KYOCERA House, Hertford Office Park,  
90 Bekker Road (Cnr. Allandale), Midrand, South Africa  
Phone: +27-11-540-2600  
Fax: +27-11-466-3050

**KYOCERA Document Solutions Russia LLC.**

Building 2, 51/4, Schepkina St., 129110, Moscow,  
Russia  
Phone: +7(495)741-0004  
Fax: +7(495)741-0018

**KYOCERA Document Solutions Middle East**

Dubai Internet City, Bldg. 17,  
Office 157 P.O. Box 500817, Dubai,  
United Arab Emirates  
Phone: +971-04-433-0412

**KYOCERA Document Solutions Czech, s.r.o.**

Harfa Office Park, Českomoravská 2420/15, Praha 9  
Phone: +420-222-562-246

**KYOCERA Document Solutions Inc.**

2-28, 1-chome, Tamatsukuri, Chuo-ku  
Osaka 540-8585, Japan  
Phone: +81-6-6764-3555

<http://www.kyoceradocumentsolutions.com>

